

RADIO PROGRESS

April 1, 1924

Cents a Copy

25
*'Always Abreast
of the Times'*

IN THIS ISSUE: *RL*

How to Make Your Ground Better
Non-Squealing Regenerative Radio
Most Important Part in Building Set
What Happens When You Oscillate
What Will Broadcasting be in 1925?

YOU WILL UNDERSTAND THIS
MAGAZINE--AND WILL LIKE IT

This Issue 15,000 Copies

PUBLISHED TWICE A MONTH



April 1, 1924

Cents a Copy

RADIO PROGRESS

25
*'Always Abreast
of the Times''*

IN THIS ISSUE: *RL*

How to Make Your Ground Better
Non-Squealing Regenerative Radio
Most Important Part in Building Set
What Happens When You Oscillate
What Will Broadcasting be in 1925?

YOU WILL UNDERSTAND THIS
MAGAZINE--AND WILL LIKE IT

This Issue 15,000 Copies

PUBLISHED TWICE A MONTH



MAR-CO

RADIO PRODUCTS

The Best in Design, Finish and Workmanship

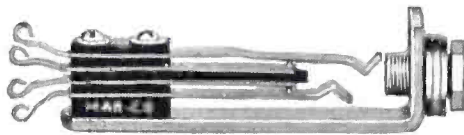

Good Wiring Means Heavy Wire

You can easily connect heavy wire
to the special loop terminals on

MAR-CO SURE-GRIP JACKS

Nine styles—all with sterling silver contacts
Micarta insulation and heavy springs. \$.60 to \$1.25

Balancing Condenser

(left)

\$1.25



Variable Grid Leak

(right)

\$1.50

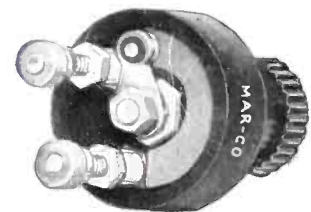

A new neutralizing condenser. Bakelite insulation. Nickel-plated working parts. Easy to mount. Easy to adjust.

A new Grid Leak, ranging in smooth easy adjustment from 1/5 to 5 megohms. Bakelite insulation. Entirely enclosed weather-proof construction.

Send for Circulars

Showing Over Thirty Radio Accessories

MARTIN-COPELAND COMPANY

Department RP

PROVIDENCE,

RHODE ISLAND

If your dealer buys
his Radio merchandise
from us

What he sells you is O. K.

We are Rhode Island distributors for
All leading manufacturers of
sets and parts

UNION ELECTRIC SUPPLY CO.

60 PINE ST., PROVIDENCE, R. I.

Wholesale only. Positively no merchandise sold at retail.

Are you Building a
RADIO SET?

If not, are you planning to build one?

We will give you whatever parts you need,—or we will
give you a Complete Set,—if you will get a few of your
friends to subscribe to RADIO PROGRESS.

Write to-day to Subscription Manager, RADIO PROGRESS, 8 Temple Street,
P. O. Box 728, Providence, R. I., and tell him what set or parts you want.

RADIO PROGRESS

HORACE V. S. TAYLOR, EDITOR

Volume 1

Number 2

Contents for APRIL 1, 1924

	PAGE
HOW TO MAKE YOUR GROUND BETTER	5
MOST IMPORTANT PART IN BUILDING SET	8
NON-SQUEALING REGENERATIVE RADIO	9
RADIO AND PHONOGRAPH GET TOGETHER	14
WHAT HAPPENS WHEN YOU OSCILLATE	15
A LIFETIME IN A SECOND.....	16
WHAT WILL BROADCASTING BE IN 1925?	18
UP IN THE AIR ABOUT RADIO.....	20
EDITOR'S LOUD SPEAKER:	
HAM AND FAN	21
THE AIR DOES NOT BREAK.....	21
LINES FOR LADY LISTENERS.....	22
WILL CITIES OF THE FUTURE BE LIGHTED VIA RADIO?.....	23
BEHIND THE SCENES AT STATION WGY	24
RADIO REPORTED IN BEST OF HEALTH	26
THE FIGHT IS STILL ON.....	27
DR. RADIO PRESCRIBES	28
UNITED STATES BROADCASTING STATIONS	30

RADIO PROGRESS is issued on the 1st and 15th of each month by the Oxford Press at 8 Temple Street, Providence, Rhode Island. John F. O'Hara, Publisher. Gordon B. Ewing, Advertising Manager. Yearly subscription in U. S. A., \$3.00. Outside U. S. A., \$3.50. Single copies, 15 cents. Application pending for entry as second-class matter at the Post Office, Providence, R. I. Copyright, 1924, Oxford Press. Address all communications to RADIO PROGRESS, 8 Temple Street (Post Office Box 728), Providence, R. I.

The publishers of this magazine disclaim all responsibility for opinions or statements of contributors which may at any time become subjects of controversy.

GIBLIN RADIO APPARATUS

The Giblin Broadcast Receiver

THE Giblin Radio Frequency Broadcast Receiver makes it possible to obtain radio entertainment without the necessity of erecting outside antenna wires or using a troublesome ground wire. A small, loop aerial placed near the set will pick up signals, which, though they have come long distances, and are weakened by hills, valleys, trees and buildings, will be clear and of great volume. Many families, living in apartments where it is undesirable or impossible to erect antenna wires, can now hear enjoyable, ever-changing programs through the day and evening by "listening-in" with a Giblin Radio Frequency Broadcast Receiver.

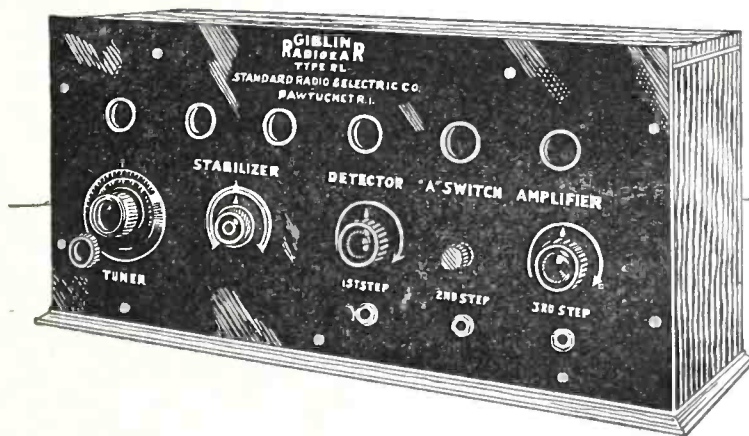

The set comprises two stages of radio frequency amplification, a detector and three stages of audio frequency amplification. The parts are mounted on a sub-base to which a Bakelite panel is attached. It is enclosed in a handsome solid mahogany cabinet.

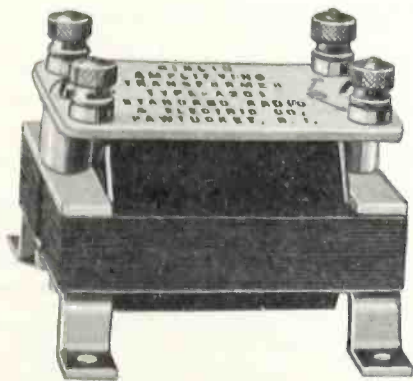

The Giblin Audio-Frequency
Amplifying Transformer
Price \$4.50



The Giblin Radio-Frequency
Amplifying Transformer
Price \$5.00

Buy Giblin Products from your dealer

Write for descriptive circulars

STANDARD RADIO & ELECTRIC CO.
PAWTUCKET, RHODE ISLAND

Radio Dealers!

This magazine will play a lively tune on your **CASH REGISTER**, if you will give it a chance!

Practically every Radio Fan who comes into your store will subscribe to **RADIO PROGRESS**, if you will keep a few copies on your counter. Those who won't subscribe will at least buy a single copy.

Why not ring up some of this business on your Cash Register? We will help you and will put you in touch with our distributor in your territory.

You'll be surprised when you discover how big an item this business will amount to in the course of a year. And you take absolutely no risk, nor do you have to invest a single cent of capital.

GET ABOARD! Write your name and address on the coupon below, and Mail it to us **TO-DAY!**



**MAIL
THIS
COUPON
TODAY!**

Date.....

RADIO PROGRESS
8 Temple Street
Providence, R. I.

Tell us how we can make money, without any effort on our part, selling **RADIO PROGRESS**.

Name

Address

RADIO PROGRESS

"ALWAYS ABREAST OF THE TIMES"

VOL. I, No. 2

APRIL 1, 1924

15c. PER COPY, \$3 PER YEAR

How to Make Your Ground Better

What Reason Have You for Thinking Yours is a Good Ground?

By HORACE V. S. TAYLOR

ALMOST every radio set must have a ground. Perhaps you think you are operating your set without one when listening to a local station if you have taken the ground wire off, but you are not. You are really using a capacity ground. A capacity ground uses the condenser action of the set itself to get the electric waves to earth. This is the way it works; the whole set is one plate of a condenser, the earth the other, and the waves go through the air between them in the same manner as they go through the variable condenser you use when you tune in your set. The same action occurs when you use a counterpoise—the counterpoise is connected to the ground post of the set, and the condenser action (as described above) carries the waves across the intervening air space, and so the set really is grounded.

The only style of set which really does not require a ground is the one using a loop aerial; we mean a real loop aerial, one that has two terminals, both brought to the set. Many amateurs use a wire wound on a square or diamond shape form, and connect the outside end only to the aerial post of their set. However, such coil does not constitute a real coil aerial. The essential difference is that a real coil aerial always has both ends connected to the set and no ground connection at all.

Some Common Mistakes

One of the common faults with the ground system of a radio set is illustrated as Fault No. 1. This shows a ground wire attached to a gas pipe.

There are two objections to this practice. As you know, gas is under a very small pressure in the pipes. As a

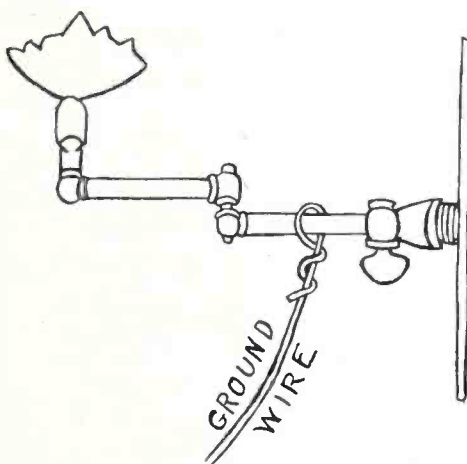

Fault No. 1

matter of fact, the pressure is so low that you can easily blow backward through a gas pipe and by filling it with air can blow out the lights in adjoining rooms. This delicate attention to one's neighbor often occurs in a college dormitory where one fellow will put out the light of his roommate at a critical point in the evening's work. On the other hand, water pipe has to stand very heavy pressure. For this reason the joints of the water pipes are usually screwed up a great deal tighter than the joints in a gas pipe. Of course a lot of the electrical resistance in a pipe may easily occur at a joint not properly tightened, and this is one very good reason why a water pipe is better for a ground than a gas pipe.

Underwriters Forbid It

Another good reason against using a gas pipe for a ground is that the fire insurance companies prohibit it. Their theory is that if a gas pipe should happen to spring a leak, and at the same time any large current should happen to go down the wire and make a spark, it would perhaps ignite the gas with resultant fire or explosion. Of course, no such danger attends grounding on a water pipe.

Another mistake along the same lines is illustrated as Fault No. 2. Here we have hot and cold water faucets. You will notice the ground wire is attached to the hot rather than the cold water faucet. The objection to this form of ground is that the electric waves will have to go to the hot water heater and perhaps to the kitchen range before they find the cold water connection and

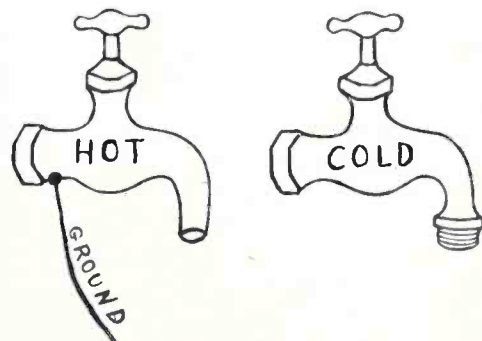

Fault No. 2

are able to run through the cold water pipes out into the ground. You will realize that the electric waves are not interested in the pipe or the wire itself,

but are only intent on reaching the real, solid ground, and so have to wander around the piping in your house until they are able to reach the service entrance of the water pipe in your cellar and go directly to the earth. For this reason, be sure that you always ground on the cold water pipe rather than the hot water.

Don't Wrap the Pipe

After you have found the correct pipe on which to ground, perhaps you have made mistake No. 3. This may seem like a simple trouble, but it sometimes causes serious difficulty in the operation of a set. You will notice the wire is wrapped around the pipe several times and then twisted back on itself. Such a method will sometimes make a good ground which will last for a short while, but eventually it is very apt to fail through corrosion of the pipe or the wire.

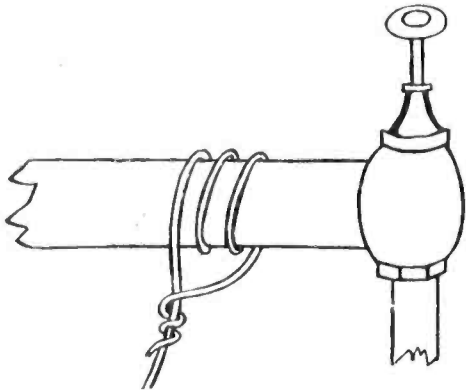

Fault No. 3

The only satisfactory way to attach your ground wire to the pipe is to use a copper ground clamp. Such a clamp can be obtained at the cost of eight or ten cents, and it is foolish to attempt to make a homemade device do the work of such a cheap piece of apparatus.

Of course, if the wire had been soldered to the pipe, it would have made a satisfactory connection, but if you have ever tried to solder to a pipe with water in it, you will know it is almost an absolute impossibility, and it is quite a lot of bother to draw the water off before attempting to solder. It is better to use the clamp.

Do You Go Up to Ground?

Some installations look like picture No. 4. You will notice here the ground wire does not run straight down, but first goes up to the ceiling and across the room before going down cellar to the water pipe. This is a mistake, be-

cause it runs so much higher than the set that it has the tendency to act as an aerial and robs the set of some of the energy it would otherwise have. If at all possible, the ground wire should run down from the set and should not rise above its level at any time before going down into the cellar. If necessary, a bare braided copper wire may be run under the carpet from one side of the room to the other. Then you won't have to go up to the ceiling at all. The braided wire will be flattened out enough so that it will not damage the carpet nor be injured itself by people walking over it.

Have you seen a radio installed with Fault No. 5? You will observe that the aerial and ground wire run side by side for a considerable distance before separating. This is like the mistake we depicted in the article on aerials in our last issue. Where the ground approaches so close to the aerial wire the condenser action between the two will steal a large proportion of the music which comes in through the air. In the illustration shown, if the ground wire had been run straight down to the floor, then along the floor to the left hand corner, it would have separated the two wires several feet apart and this would have caused no trouble.

One Wire Per Hole

Also, be sure that you do not make the mistake, which is seen so often, of running both wires through the same hole in the wall or partition. If you do, you are throwing away a good deal of your energy.

Now look at Fault No. 6. Here we have a set connected quite properly to the water pipe in the cellar, but you will notice that the wire is not continuous.

Evidently in installing this set the wire was a little short and had to be pieced to enable it to reach down to the cellar to the water pipe. Of course, such a thing often happens, but when it does,

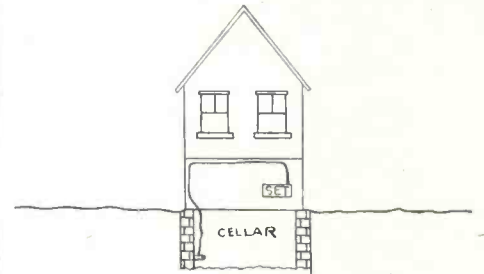

Fault No. 4

the joint should not be wrapped only, as shown in the picture; after wrapping it should be soldered. The reason for this requirement is that the underwriters specify that all joints in the ground wire must be soldered unless fastened by some sort of approved clamp. Their attitude is that the same ground wire is usually connected to the lightning arrester, and if lightning should strike your house you naturally want the ground wire as near one hundred per cent. perfect as possible, so as to make sure that all electricity will be brought to ground and none of it be left to wander around your rooms to set fire to your furniture.

Moonlight Rambles Bad for Ground

Fault No. 7 shows how a ground wire often rambles all around a house before reaching the cold water pipe. This is quite undesirable. The more direct and short a ground can be made the better your set will operate. When you have such a long wire as is shown in the picture it adds considerably to the resistance of the circuit, and this is a two-

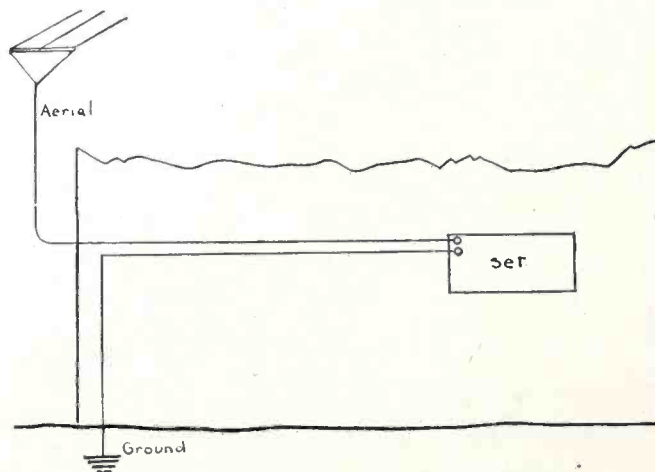

Fault No. 5

fold disadvantage. In the first place it reduces the loudness of the broadcasting, and in the second place it makes it more difficult to tune out undesirable stations. If your set does not reach out as far as your neighbors, make sure that your ground wire is direct and as short as possible.

If you find trouble in running the wire direct to the cellar, the difficulty usually is that you can not get through some floor or wall. So you must run the wire to some actual opening like a door or a crack which already exists. But this is unnecessary. For about ten cents you can buy an electrician's auger, which is about one foot long, and with it you can drill a hole through the wall or floor quite quickly and easily. The size of the hole is so small, smaller than the diameter of an ordinary telephone cord, that it is very unobtrusive. Through such a hole you can run your bare ground wire without experiencing difficulty, and by doing so the wire will be short and direct, as it is necessary for best reception.

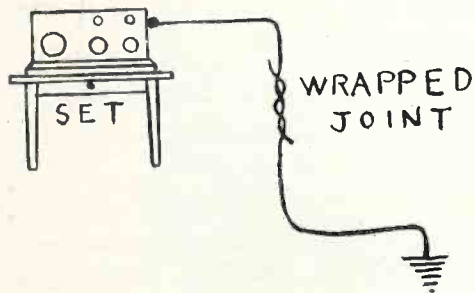

Fault No. 6

Oftentimes grounding on your radiator is a case of rambling. Before you ground on your radiator, make sure that the radiator pipes are pretty straight down to your cellar, and that the cold water pipe running to your furnace is not unduly long and winding. You see, the radiator itself is not a ground, nor is the furnace. It is only because the radiator pipes connect to the furnace, and the furnace connects with the cold water pipe that it is satisfactory to use the radiator at all. If these pipes are comparatively short and direct, then no harm can be done to your reception, but if they ramble around the house before getting to the cold water outlet, you will get better operation if you run a ground wire direct to the water pipe. A further objection to grounding on the radiator is that if you have an outside aerial the underwriters require that you have a

direct wire ground running down to the water pipe, and they will not pay your fire losses when the house burns if they find you used the radiator for a ground.

Just Where Should Ground Be Connected to Pipe?

By the underwriters' rule the place to attach your ground clamp and wire is on the cold water pipe just as close as possible to the point where it enters your cellar. This is usually right by the water meter. If your house is wired for electricity, you will doubtless find that the lighting people have used the same place as a ground for their equipment. If such is the case, it does no harm for you to ground an inch or so away from these connections, and right on the same pipe.

If You Have No Running Water

But let us suppose you are in the country and have no running water. What is the best method of making a ground under such conditions? Some exhaustive tests on grounds have lately been conducted by the *Electrical World* and reported by them in recent issues. Should you have no city water supply coming into your cellar, the best method is to drive some pipes down into the ground and connect to them. However, do not make the mistake illustrated in Fault No. 8. You will notice this pipe is not driven very deep. In order to make a good ground, it should enter permanently moist soil to a depth of three or more feet. Since the permanently moist soil is usually found at least four feet below the surface, it means that your pipe should be driven to a depth of seven or eight feet. In driving it is not necessary to buy a special tip, as it is found that a pipe with an open end will penetrate most soils that are not too stony in character. In case your land contains too many small stones it becomes rather difficult to force a pipe down to such a depth. Here the best method is to get a sharp pointed steel rod and drive it down first, then remove it and drive the pipe in the same hole. Care should be taken to use a steel rod smaller in diameter than the iron pipe because it is quite necessary that the pipe fit tight in the hole to give a good contact to the surrounding earth. The upper end of the pipe may be left projecting as far as you like. It should be attached to the ground wire by a copper ground clamp.

If you are using this style of clamp do not make mistake shown in Fault No. 9. This mistake consists in using a single pipe driven in as described. Such a pipe, owing to its short length, has a high resistance. If you are using driven pipes for ground, at least two should be used, and three would be better still. If they are spaced as far as five feet apart, the resistance is reduced to half or one-third, but even if they are only a couple of feet apart, the second helps quite a lot in reducing the resistance and so improving the operation of your set. In connecting up two or three pipes, run a wire to each pipe, and then solder these two or three wires together and to the ground wire running to your set. This will make quite a satisfactory installation.

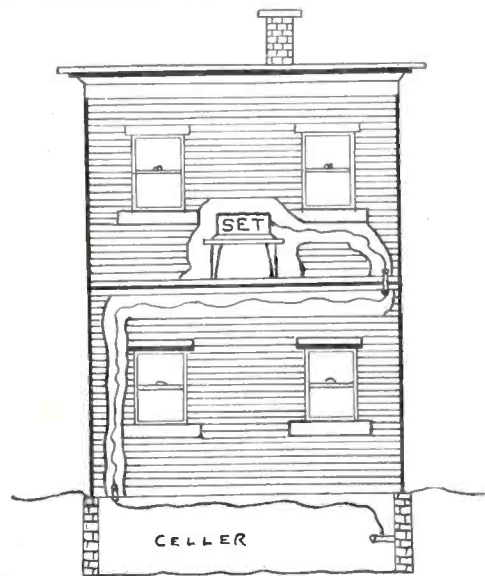

Fault No. 7

Fault No. 10 is difficult to illustrate. It consists of attaching a ground clamp to your pipe without properly attending to its surface. When a pipe has been in use for some time it becomes dirty and oftentimes rusty or corroded. Such a coating on the outside is a pretty good insulator to prevent radio waves getting from the clamp to the pipe itself. The only good method of removing this scale is to take a piece of sandpaper and polish the outside of the pipe for the length of a couple of inches. When it has been brightened up so it shines all the way around, you can put the ground clamp on. If you screw it down tight, you will find the good contact you get will last over a long term of years.

This may seem like a small point, but many a radio set is crippled somewhat in its operation by carelessness in this regard.

Continued on Page 8

Most Important Part in Building Set

Story of How One Radio Builder Nearly Came to Grief Through Oversight

An Interview with Mr. Montmorency, the Boston Banker

MANY people in building sets use some unnecessary parts while others perhaps leave out some items which would be a distinct improvement to the set. A case of this kind was recently explained by O. Albert Montmorency of Beacon street, Boston. Mr. Montmorency is a banker in the daytime but in the evenings he has been building crystal sets with the help of his son. Recently he decided to try building a tube set but when he got the apparatus ready he found that—but let him tell it:

"I have tried out most every kind of a crystal set," said Mr. Montmorency, "and I have had pretty good success with all of them. The one that worked best of all was modeled after a set described as a fool proof radio in one of the new radio magazines.*

Getting the Distant Stuff

"But I finally decided that I wanted to get broadcasting out of the city and so looked around to see what kind of apparatus to buy. Should it be a one, two, or three tube set, or should I build one of those big eight tube outfits, and then how about radio frequency and audio frequency. Here my son was able to help me considerably. He said that

the thing to do was to start with a single tube set using a regenerative hookup. That would make it a lot easier to locate any troubles which might develop and then we could afterwards add two stages of audio amplification, so on this basis we got down to work and made a list of the various parts which we should need. We found the advertising pages of the radio magazines quite helpful in making a choice. After the list was done my son asked if I had put down the most important thing of all. I told him that I hadn't, as there was no chance at all of forgetting that. 'Well, don't you come back without it,' he said.

"As I left on my way down town my wife handed me a list of things that I was to get for her and incidentally she asked if I had made out my own list of radio parts as otherwise she knew that I would forget something. 'I have down everything, but the one thing that I can't forget,' I told her. 'I know what you mean,' she replied, 'and don't come home without it.' 'Not a chance,' I said. When I reached the radio store I found the dealer had everything in stock that I wanted. The dealer explained that it was easy to get the advertised parts al-

most anywhere, so he quickly filled the order which I gave him. He told me the single circuit regenerative was an easy one to hook up and he thought I should not have any trouble with it as I had all the necessary parts.

Easy to Forget

"When I arrived home late that afternoon I was met at the door by the family, who cried in chorus, 'Did you get it?' I instantly knew what they meant. 'By Jove, I forgot it at that,' I exclaimed. 'Well, you will have to turn right around and go back and get it,' said my wife. When I reached the store the dealer was apologetic. 'Of course I thought you had one,' he said, 'or I would have called your attention to the omission when you were buying the rest of the parts. It is the most important thing to get when building a set.'

"I now hurried home the second time. Again the family was waiting. 'Here it is,' I said as I handed them the last copy of RADIO PROGRESS."

**Editor's Note.* He evidently refers to "A Fool Proof Radio" in the March 15 number of RADIO PROGRESS.

HOW TO MAKE YOUR GROUND BETTER

Continued from Page 7

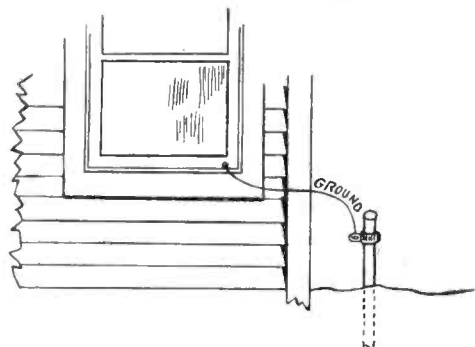

Faults Nos. 8 and 9

What About Insulated Wire?

Many amateurs use insulated wire for the ground. There is no real objection to this practice. However, it is going to unnecessary expense to put an insulated coating on the wire you are to

use for the ground. The idea is the radio waves come in through your aerial and do their best to get to ground. The aerial for this reason must be insulated (either by using insulated wire, or by supporting bare wire on insulators) if you want the waves to go through your set; but after they have gone through and made music in your phones, you want them to reach home (ground) as soon as possible. How unnecessary it is, then, to cover the ground wire with insulation. If this wire *should* happen to touch any piece of metal, like a furnace pipe, for instance, it would improve the operation, if it had any effect at all, because it would give the radio waves an even shorter path to ground. On the other hand, if it did not happen to touch any metal, then it would be insulated, even though bare wire, and any further insulation on the wire would be entirely

superfluous. Dry wood or plaster, you know, is a good insulator. With nothing to lose and the possibility of gain, there is no reason why bare wire should not be used. But if you already have insulated wire installed, there is no particular advantage in tearing it up, but on new work, use bare wire. Ordinarily, No. 14 is recommended by the fire insurance companies, unless it is connected to the lightning arrester, in which case No. 10 wire is specified.

On the whole, if you will look over your wiring with the idea of getting the electricity from your set to a good moist ground just as quick and direct as possible, you may find that you can improve the operation of your set at a very small outlay of money and time.

In the next issue we shall discuss some of the ordinary errors we find in the installation of lightning arresters.

Non-Squealing Regenerative Radio

"Teledyne" Circuit is One of the Recent Developments in the Non-Radiating Sets

By H. S. WILLIAMS, Radio Engineer

(EDITOR'S NOTE: If you have followed recent discussions in the technical papers, you will notice that the burning question of the hour is the non-radiating set. In some congested districts it is practically impossible to get any kind of decent reception from distant stations until eleven or twelve o'clock at night, when most of your squealing neighbors have gone to bed. Several non-radiating hook-ups are on the market at the pres-

ent time, but practically all use the plan of substituting radio frequency for regeneration. However, it is not necessary to sacrifice regeneration. One of the first radios to retain this feature and yet omit the squeals is the so-called "Teledyne," "tele" meaning distance and "dyne" meaning power.

This set was designed and built by Dr. Bowden Washington of the Cutting & Washington Radio Corporation, and

it excels in range, volume and selectivity.

Mr. H. S. Williams, Radio Engineer, has written a series of two articles on the "Teledyne." The first one explains the circuit and tells how to build a set; the second discusses the best aerial and ground for use with this set and describes the method of tuning and operation.)

THE "Teledyne" was designed with two primary objects in view. The first was to produce a powerful and simple regenerative receiver that would not "transmit" or "re-radiate." The second was to increase the range, volume, clearness and selectivity of four-tube receivers.

Both of these objectives have been obtained. By a series of engineering

experiments it was found by Dr. Bowden Washington that it was possible to eliminate "re-radiation" from regeneration. This accomplishment, in itself, will appeal to the radio fan who is continually annoyed by squeals and catcalls from neighboring receivers as one of extreme importance.

The average fan may ask why is regeneration necessary. The discovery of

regeneration was a great step forward in radio reception. It made a vacuum tube almost a hundred-fold more efficient, bringing about considerable economy in tubes, coupled with greatly increased sensitivity and selectivity.

When radio-phone broadcasting swept over the country, regenerative receivers fairly "rained down upon the listening public." Unfortunately, insufficient

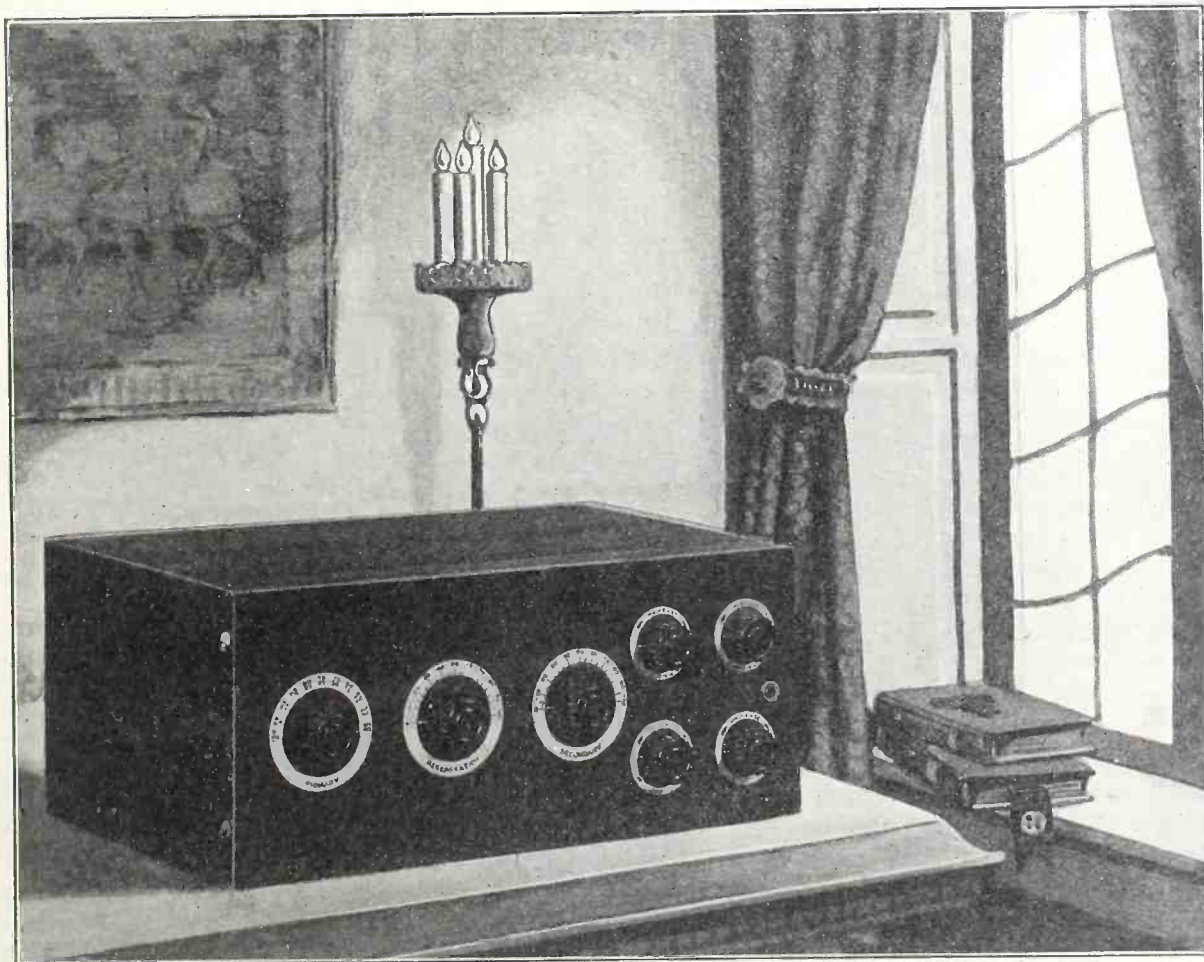

A Delight to the Eye, as Well as to the Ear

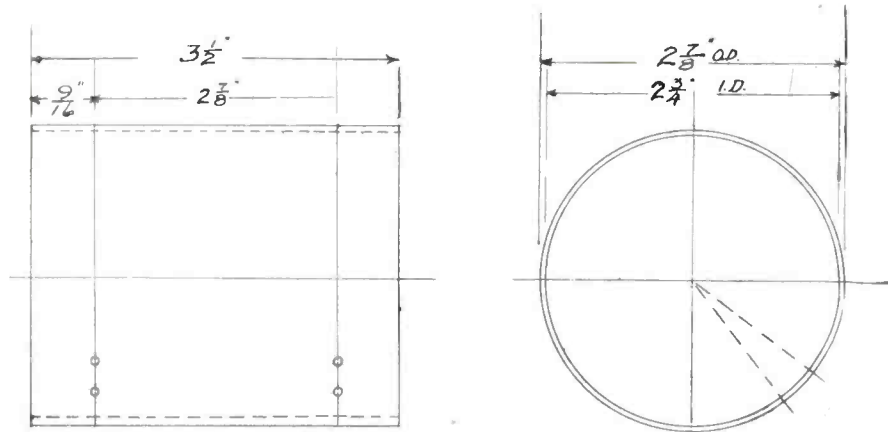

2 7/8" O.D. x 2 3/4" I.D. x 3 1/2" OF FORMICA OR BAKELITE TUBING NATURAL

FIG. 1.

Primary Coil is Wound on This Tube

thought and foresight were used in the beginning, and the radio fan was presented with what has turned out to be the curse of the ether—the single circuit regenerative receiver. It was this type of receiver with its many drawbacks that brought regeneration into such disrepute.

Preventing a "Spill"

It was not regeneration, however, which was at fault, but, rather, the way in which it was used. It is a force, a very potent force, which, when intelligently utilized, opens up infinite possibilities in the field of broadcast reception. The problem in regenerating radio frequency amplifiers is the tendency to spill over into oscillation. Neutrodyning prevents the tubes from oscillating, but with a sacrifice in sensitivity, for it also prevents the tubes from regenerating.

The problem of utilizing regeneration with its unquestionable advantages without danger of self-oscillation was solved by Bowden Washington by taking the principle that when a resonant circuit, consisting of an inductance and capacity in parallel, is placed in series with the plate circuit of a vacuum tube, the grid circuit of which is also resonated to the same frequency, the resonant plate circuit will produce oscillations, and just off this resonant point, negative resistance or regeneration. The research finally was simplified down to the point where the coupling was made at a certain critical value, thus preventing oscillation.

The Teledyne comprises four tubes, namely, tuned radio frequency, regenerative detector and two stages of audio

frequency, the circuit being so developed as to be very selective and give coast to coast loud speaker volume under good conditions.

There is just sufficient regeneration intended in the antenna circuit to minimize to a marked extent ill-constructed antennae. The minimizing of antenna resistance aids volume and selectivity.

The tuned radio frequency stage is coupled in a peculiar manner to the grid of the detector, which, with both tuning and regeneration, gives enormous amplification with greater selectivity. Under ordinary conditions the radio frequency stage amplifies the very weak incoming signals nearly 10 times. This amplified oscillation is then impressed upon the grid of the detector, where, through means of controlled regeneration it is again amplified as much as one hundred times.

Whistles Don't Disturb Neighbors

The amplification in the detector circuit is a material aid to ease in tuning. The detector circuit can be made to oscillate without antenna "re-radiation" and therefore pick up distance carriers

through the conventional beat or whistle method without the necessary hunting for the stations.

Once this carrier is located, all that is necessary to bring in distance signals is to tune the antenna control until the signal or beat is loudest. The regenerative control may be turned back slightly if necessary and the signals left clear and loud. The set therefore has only two major controls, comprising the secret of easy and simple tuning.

The Teledyne also uses a four and one-half volt "C" battery, which is intended to give "B" battery economy along with loud speaker volume.

Materials Needed

The following list of materials should be followed as closely as possible, and where any alterations or substitutions are necessary, equally as good parts must be secured.

Primary Coil Tube

One Bakelite tube two and seven-eighths outside diameter, one-sixteenth inch wall and three and one-half inch long.

Secondary Coil Tube

One Bakelite tube four inch outside diameter, one-sixteenth inch wall and two and one-eighth inch long.

Regeneration Coil Tube

One Bakelite tube three and one-fourth inch outside diameter, one-sixteenth inch wall and three-fourths inch long.

Four UV 199 tube sockets. These should preferably have shock absorbers.

One Dubilier grid condenser, type 601, G capacity, .00025 mfd.

One phone condenser, capacity .002 mfd.

Two by-pass condenser, capacity .1 mfd.

One spool No. 26 double silk covered magnet wire, 1/4 lb.

One variable condenser capacity (11 plate).

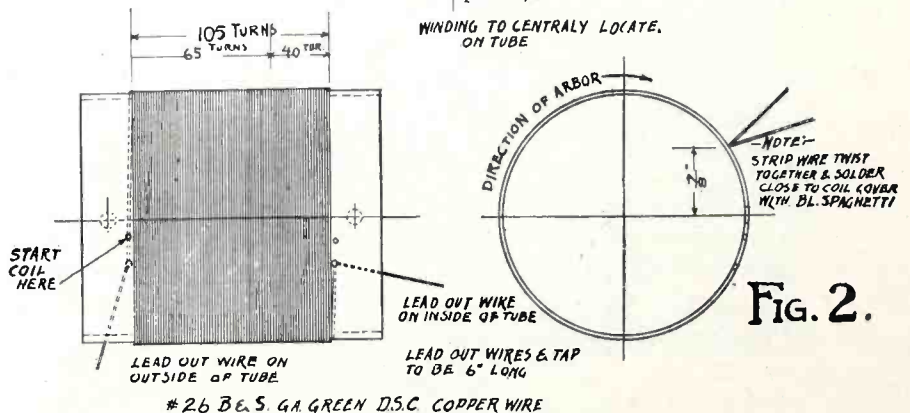

FIG. 2.

26 B.E.S. GA GREEN D.S.C. COPPER WIRE

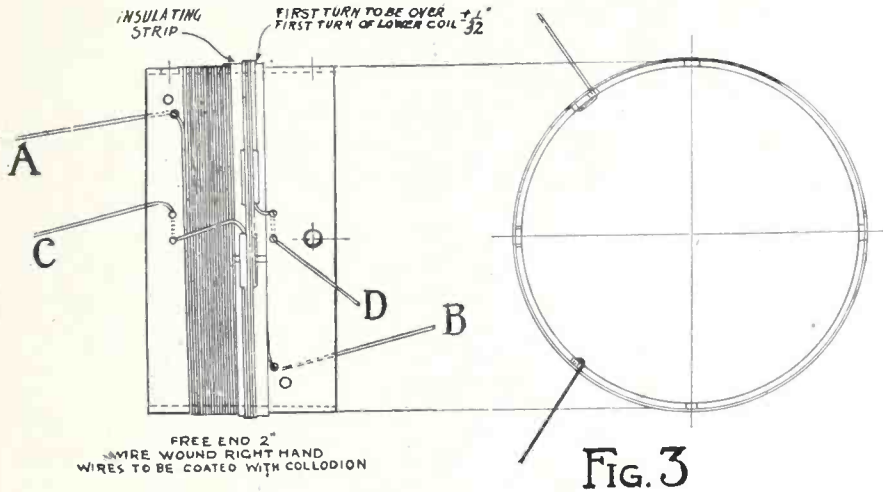

FIG. 3

turns. Loop the wire at this turn and take off a tap, leaving about six inches for connecting to the switch point. Continue in the same direction until 40 more turns are wound on. Anchor this as indicated, leaving as before about six inches for connecting. A diluted solution of collodion, procurable at a drug store, may then be used to coat the wiring so that there will be no possibility of the wire coming loose or sliding off the coil.

Secondary Coil

Fig. No. 3 shows a complete sketch of a Teledyne Secondary. There are two windings on this coil, the lower one being the detector grid coil, or the secondary, while the small four turn coil wound over this is the plate delivery coil of the radio frequency tube. The latter is especially critical and should be wound and placed exactly as in the drawing. Separating these two coils is a thin piece of bakelite or impregnated cardboard. If the latter is used, it should be thoroughly dried and then impregnated in a diluted solution of collodion. This prevents absorption of moisture and assures better operating conditions. The strip should not be more than a thirty-second of an inch thick and about $\frac{3}{8}$ inch wide. A strip $12\frac{3}{4}$ inches long will just go around the secondary coil over the other winding.

Lay out the holes for the secondary tube according to Fig. No. 4. The three holes marked $\frac{13}{64}$ inch drill may be omitted if the circular bracket as found in the Cutting & Washington set is not used. A different form of mounting will of course require a different bracket and hence different holes. To those who have not had experience in reading blue-prints, Fig. No. 3 will probably suffice.

One variable Vernier condenser (11 plate).

Two All-American amplifying transformers, high impedance, ratio 5 to 1, or equivalent.

Two Carter switching rheostats, resistance 30 ohms.

One plain rheostat, resistance 20 ohms.

One two spring jack.

One Bakelite panel, approximately 8 by 18 inches (depending on space available).

One shield plate slightly smaller than panel or at least large enough to cover the condensers and coils. The transformers and rheostats need not be shielded.

Five or more dials, depending on whether or not separate Verniers are used.

One switch contact arm of conventional design with two switch contact points.

Miscellaneous brackets for the coils and tube sockets, transformers, etc., and a suitable shaft for the regeneration coil will be left to the builder's discretion. They may be of anything, preferably brass or bronze, and may be shaped to suit the particular style of layout that the builder contemplates. Either hard or soft wire may be used for connecting the various units.

Eleven binding posts will be required, one each for the Antenna, Ground, Negative A, Positive A, Negative B, Detector B Positive, Amplifier B Positive, Negative C, Positive C, and two for the horn. If flexible leads are used, as in the Cutting & Washington Teledyne, all but the first and last two may be discarded, and soldering lugs used in their place to which the flexible leads are soldered.

Painstaking care in assembling is a most important thing in building a Teledyne for results. The winding of the coils is probably the most difficult operation of the process, but even that should not be alarming if instructions are followed carefully.

The following formula is intended to take the builder through the work, step by step, in proper order of assembly and wiring. If it is followed closely, the work is simplified considerably.

Primary Coil

As accurately as possible, lay out the location of the holes for the beginning and end of the primary winding as per Fig. No. 1. A No. 55 drill is commonly used to drill these holes, but other sizes are permissible, depending on what is handy. Too large a hole is not to be recommended, however. Referring to Fig. No. 2, 105 turns of the No. 26 double silk covered wire are to be wound on this coil. Starting at the left end of the coil, as in Fig. No. 2, and turning the coil in the direction indicated by the arrow, wind on, as close as possible, 65

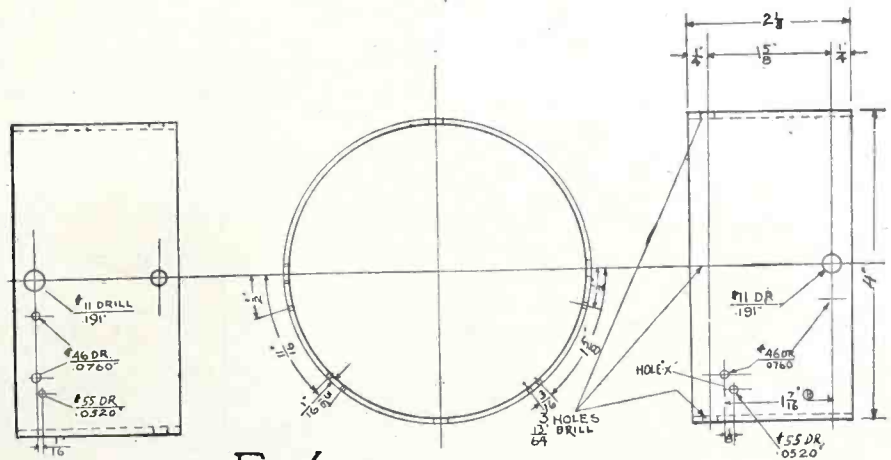

FIG. 4.

4" O.S. DIA X $\frac{1}{16}$ " WALL BLACK BAKELITE TUBU

The anchor holes may be drilled approximately correct or as near as can be judged. The only holes which must be at all accurate are the two holes through which the regeneration coil shafts run. These, of course, should be quite accurate, otherwise the dials will probably wobble when attached to the shaft.

Winding is Important

Winding the secondary is next. Start at the left at Fig. No. 3. Wind in the direction shown in the drawing and continue until 45 turns of the No. 26 double silk covered wire are closely wound. Anchor as before, leaving several inches for connecting. Coat the coil with collodion as was the primary. Procure the bakelite or cardboard strip. Fasten close to the right-hand end of secondary coil with collodion or a rubber band. This is illustrated in the sketch. Once the wire is wound in place over this strip, it will hold itself. In the meantime, if the rubber band or collodion is not sufficient to hold the strip, a drop of glue may be used on the ends. As shown in the drawing, this delivery coil, as it is called, is comprised of four turns of the same size wire as used before. It is wound in the same direction and very carefully placed so that the last turn of the delivery coil is over the last turn of the secondary winding. This is quite important. To aid in holding the wire small pieces of cloth tape must be inserted under the windings, the ends of the coils slipped through the loops and the loops pulled tight. The coil is then coated with collodion as before and allowed to dry.

Regeneration Coil

Reference to Fig. No. 5 will show how the coil is to be prepared before winding.

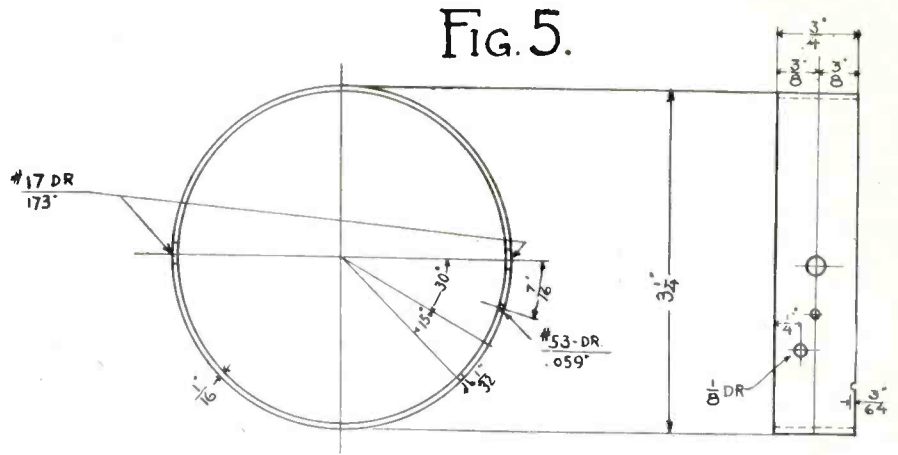

3 1/4 OS. DIA. x 1/16 WALL BLACK BAKELITE TUBE

The two No. 17 holes are for the shaft. Fig. No. 6 will show the method of winding. The same size wire is used as on the other three coils. Care should be exercised here as before to see that the windings are close together and properly placed. It likewise should be coated with collodion and allowed to dry before handling.

With the aid of a few shafts and bolts the secondary and regeneration coils may be assembled somewhat as in Fig. No. 7. The inside of the regeneration coil should be that side having the winding on it. If this is true and all the winding directions are as given in the prints, the rear connection or that one marked "P" will go to the plate of the detector tube, while the remaining one or that one marked "B" will go to the outside winding of the audio transformer primary and thence to the detector "B" battery. The experimenter will undoubtedly have many ideas as how to assemble the regeneration and secondary coils so that part will be left entirely to the builder's discretion. All that must be

remembered is that the regeneration coil must be swung inside the secondary coil at the end opposite to the one carrying the plate delivery coil of the radio frequency tube. The assembly of this complete assembly in turn will depend upon the particular style of panel layout that the builder is using.

Panel Layout

While the assembly and panel layout of the Teledyne will depend upon the particular kind and quantity of apparatus on hand, still there are certain fundamental principles which must be borne in mind while this work is going on. A general idea of this can be gained by glancing at the accompanying photograph of the Cutting & Washington Teledyne. Here you will note that the primary condenser is mounted at the left with the primary coil fastened directly to it. The coil is exactly vertical. This is important. To the right of this is the secondary and regeneration coil assembly with the regeneration dial working to the regeneration coil by means of a train of gears. The radio frequency tube socket is mounted directly between these coils. This makes short and direct leads possible. To the right of the secondary regeneration coil assembly is mounted the secondary tuning ll plate condenser. The vernier in this case is separate and actuated by a separate control to the right of the main control. This is not essential, as any type of vernier condenser is suitable.

Use Shock Absorber

In the rear on a special shock absorber mount are placed the grid condenser and leak to the left, while the detector and two audio frequency amplifier tube sockets are to the right. A patented

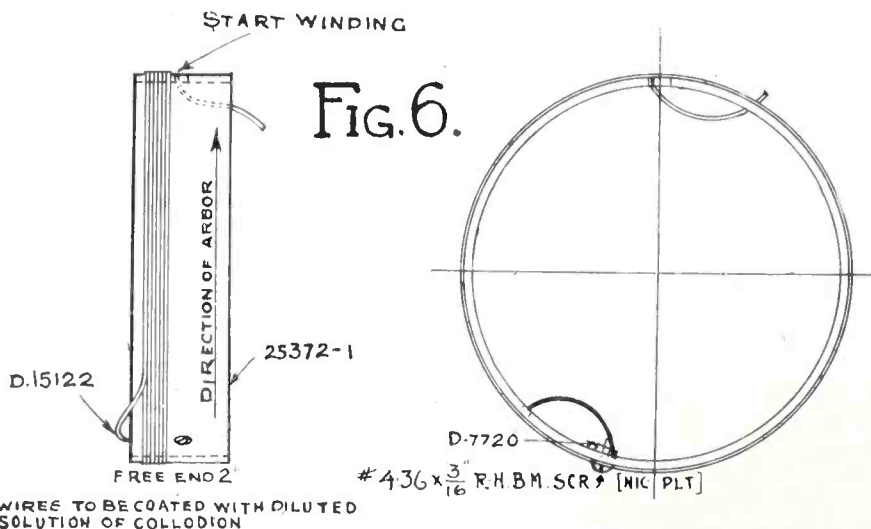

switching condenser used in place of the ordinary primary condenser make the use of a switch lever and points unnecessary. These are not procurable on the market, so it becomes necessary to use the switch lever and points instead. These should be mounted at the left of the panel so as to make short leads from the primary coil possible. The rheostats may conveniently be mounted to the right, since this is the audio side. Likewise it might be advisable to mount the audio frequency amplifying transformers to the right close to the tube sockets. This also makes for short leads.

The mounting of the separate units is also left to the builder's ideas. It may be well to use a base board to which the front panel can be mounted so as to allow the units to be mounted more conveniently. For instance, the primary coil can be mounted directly on the primary condenser. The radio frequency tube socket can then be mounted on the base alongside of it, making short leads possible. The secondary regeneration coil assembly next to this either to the base or to the panel, but at right angles to it and with the center line of the primary winding exactly on a line with the center of the secondary. This is important. In other words, the two coils should be exactly in line both ways, but at right angles to each other. The secondary variable condenser can then be mounted to the right of this assembly with both the amplifying transformers and tube sockets near by. The jack is conveniently mounted at the extreme right of the panel.

A word of caution here. Care should be taken when arranging the apparatus to see that all connecting wires will be as short as possible and at the same time not come too close to one another. This applies especially to the radio frequency leads. When the binding posts and other odds and ends are connected and assembled, the set is ready for wiring, as shown in the next issue.

AS TO THAT PRIZE CONTEST

We are getting in some very choice stories of the marvelous operations of various sets and other kinds of radio equipment. The contest closes April 5, so hurry in your own story or prize lie. To the one sending the largest lie or the strongest story will be awarded a year's subscription to RADIO PROGRESS, as announced in the last issue.

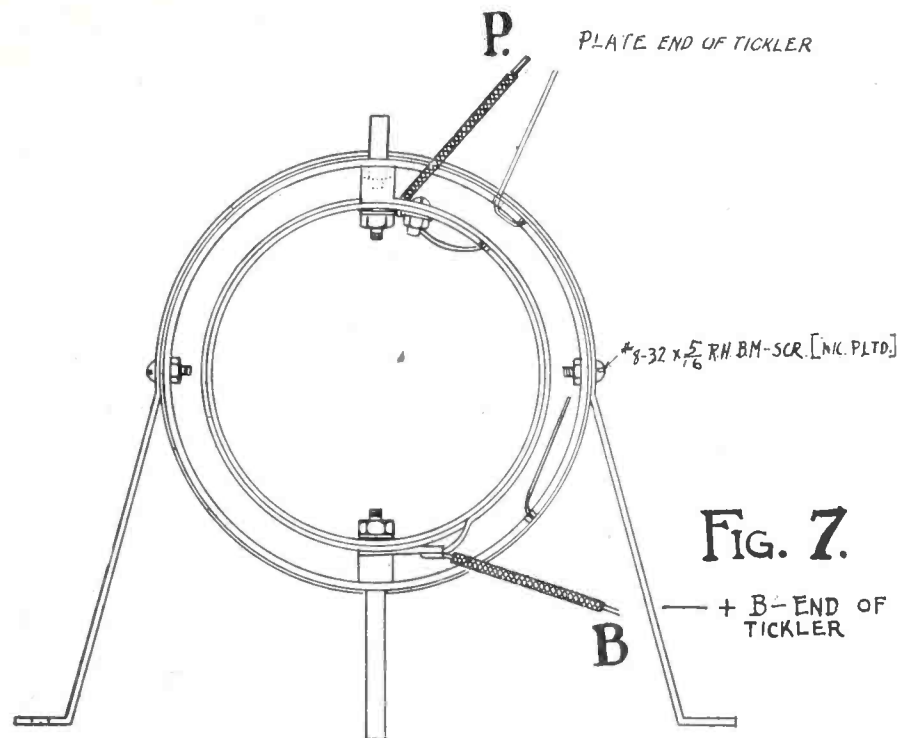

Be Very Careful Not to Get These Wires Crossed, or It Will Reverse Their Polarity

CALIBRATING YOUR WAVE METER

Many amateurs have bought or built wave meters which work very satisfactorily in general, but which are not calibrated to read accurately in wave length. One way of overcoming this defect is to send the wave meter to the Bureau of Standards in Washington. There they will mark the dial for you, and of course such data as they give will be absolutely correct and accurate. But this entails some time and expense.

Another way of checking the wave meter is to mark on it the wave length of the various stations you hear, looking up their figures in meters on page 31 in this issue of RADIO PROGRESS, but here we run into a difficulty. Notice how many stations are scheduled for 360 meters, and you know by experience that they do not all come in at the same place on your dials. The reason is that any station which is nearly 360 meters is written down at that exact figure, so the real value of the wave length may be 355 or 365 meters, and still it is called 360 meters. A further reason is that most stations are so inaccurately operated that the wave length will often fluctuate as much as three or four meters up or down.

To overcome this trouble the Bureau of Standards at Washington has recently

completed a long series of experiments to see which broadcasting stations do hold to a fixed value. So far they have certified two only, KDKA at East Pittsburg and WGY at Schenectady. The former station, they find, holds to 326 meters with an error of less than one meter up or down; the latter has a wave length of 379 meters with a variance of not more than one meter up or down. You will notice in the newspapers this station is called 380 meters. Work is still proceeding at the bureau to check other popular broadcasting stations, and when they find the wave lengths hold to a fixed value over a long period of months, they will make further announcements of such stations.

HOW WOULD YOU LIKE TO BE THE MAIL MAN?

If you get several letters a day perhaps you think you have a heavy mail. How would you like to be a big broadcasting station and get more than 170,000 letters inside of a couple of weeks? This is the mail one big broadcasting station received recently. Among these letters were applause cards for the various performers, requests for favorite numbers to be played again, and last, but not least, a good many "mash" notes for the announcer and his company.

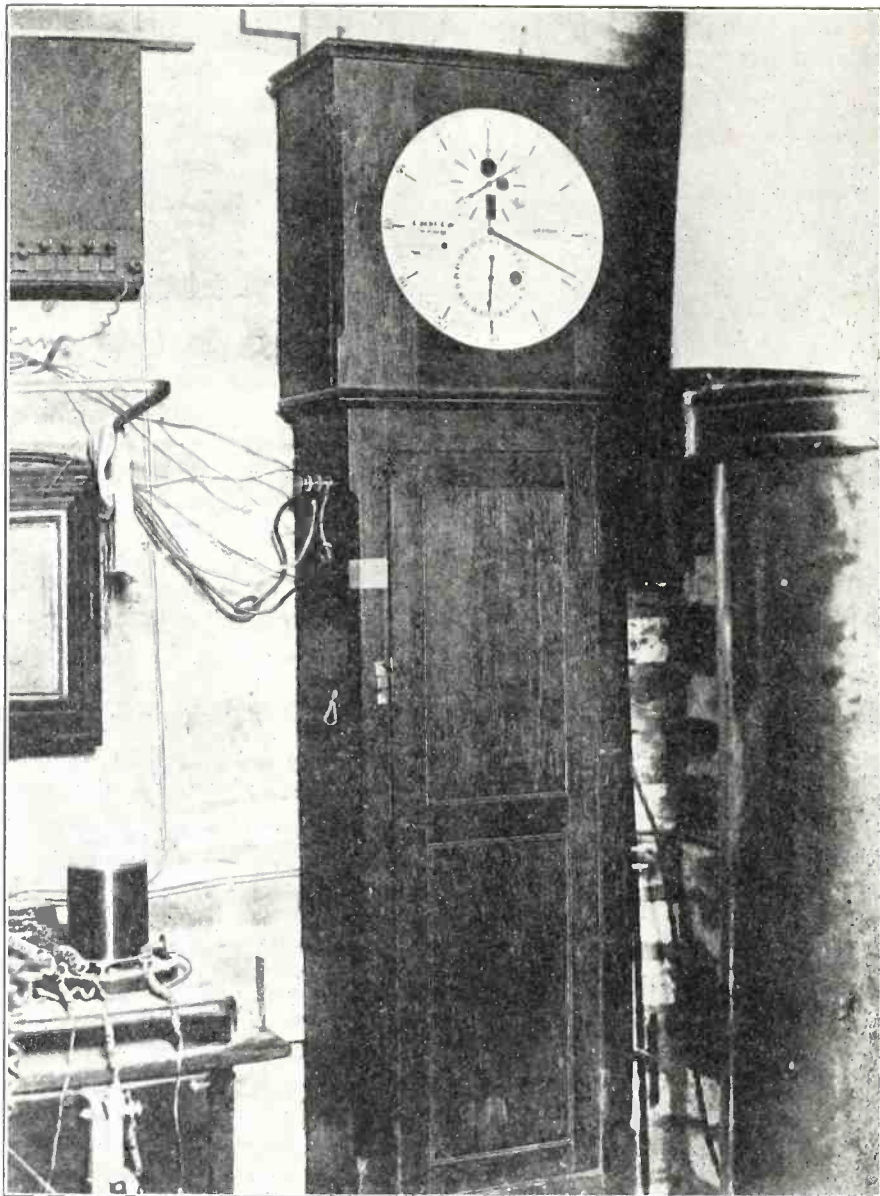

—Underwood & Underwood

This Clock is Standard of the World.

In the picture above you see the standard clock of the world. This clock is so accurate that the sunrise and sunset is timed by it. A year ago the moon arose two minutes too soon and they had to hold it back until the clock caught up.

This clock is located at the Royal Observatory, Greenwich, England. On your maps you have no doubt noticed that all longitude is reckoned from the meridian at Greenwich, so much east or west longitude. The zero line is the meridian which runs thru this observatory and is known the whole world over as the place where time starts. The Astronomer Royal of Great Britain has arranged with the British Broadcasting Company, so that in the future this clock will keep time for the British Isles the same way that NAA (Arlington) does for the United States. The time signals

will be broadcast over the whole British Isles and will be relayed by various local stations, so that anyone with a crystal set within range can set his watch accurately. This will cause a lot of hardship to the fellows whose excuse for being late is "my watch was slow."

HONDURAS NOT BEHIND THE TIMES

One of the largest radio commercial stations using vacuum tubes for transmission has been started at Tegucigalpa, Honduras. This broadcaster is using a 20 kilowatt power tube. The station is one of several of a similar nature which are being installed all through Central America by the United Fruit Company. You see, they are taking care never to run out of bananas again.

RADIO AND PHONOGRAPH GET TOGETHER

AN announcement of importance to both the public and the radio and phonograph industry was made by David Sarnoff, Vice-President and General Manager of the Radio Corporation of America, recently as follows:

"Through an agreement just signed between the Radio Corporation of America and the Brunswick-Balke-Collender Company, phonograph manufacturers, millions of radio fans throughout the United States will receive for the first time operatic and musical programs rendered by famous artists whose services hitherto have not been available to the broadcasting companies.

"Although sporadic attempts have been made to combine radio and the phonograph, the announcement made today by the Radio Corporation of America of a contract which not only will effect a marked improvement in future broadcasting programs, but which involves the sale of combined Radiola-Brunswick phonographs, is accepted as the first definite indication that large interests in the phonograph industry have now determined to combine the best features of radio and the phonograph in a single instrument.

"Under the contract recently concluded the phonograph company gains the right to install Radiola receiving sets in combination with Brunswick phonographs. In turn, the phonograph company will add its share to the public service now rendered by the principal broadcasting stations and aid the development of free broadcasting to the public, by permitting the stations of the Radio Corporation of America and those of its manufacturing associates to broadcast from the laboratories of the Brunswick Company during the periods when its artists are recording for phonograph reproduction, and to encourage these artists to aid the programs at other times as well.

"The areas that will benefit particularly by this new arrangement are those served by the broadcasting stations of the Radio Corporation of America, the General Electric Company and the Westinghouse Electric and Manufacturing Company, in New York, Washington, Chicago, Hastings, Neb., Springfield, Mass., Schenectady, N. Y., Pittsburg, Pa., and Oakland, Cal.

What Happens When You Oscillate

Maybe Your Set Has Been Doing It All This Time and You Didn't Know It

By Vance

IN the last issue of RADIO PROGRESS it was promised that a discussion would be given of the term "oscillation." Some people mistake this word for "osculation." The difference between the two is that the latter causes a vibration to run up and down the spine, while with the former the vibration is confined to the wires.

When anything oscillates it vibrates back and forth quite rapidly; thus musicians speak about the sound from a violin causing oscillations in the air. As a matter of fact, it is the oscillation of the particles of air which conveys the tone from the violin to our ears. Suppose, for instance, we have an alarm clock. When the alarm goes off our ears are strongly affected, as we all know at seven o'clock every morning. But suppose this same alarm clock is put in a glass case and connected to an exhaust pump. While the alarm is ringing, set the exhaust pump going so that it will suck the air out of the glass case and leave a vacuum. As the pressure of air keeps falling we note that the sound of ringing gets fainter and fainter, and in a short time we do not hear the alarm at all, although we can see the hammer buzzing back and forth against the bell as we look through the glass. Here we have a case of the vibration being suppressed because no air is left to vibrate.

Electrical Oscillations Similar

When electricity vibrates back and forth in a wire we call it oscillation, just exactly as we did in the case of the air. Any piece of apparatus which makes electricity vibrate is termed an oscillator. The most usual form of oscillator is a detector tube in a regenerative circuit when improperly adjusted. It is these oscillations which cause the squealing which so often comes in over the air during the evening. The trouble is that the regeneration is turned on too much. Another name for this regeneration is feedback, or tickler. No one knows why it was ever called a tickler, for no one is ever tickled with it. On the contrary, it is claimed it causes more

profanity among the neighbors than any other part of radio.

Like an Automatic Pistol

To understand the operation of the feedback, suppose we have an old pistol. The trigger is very stiff and rusty, and it requires a pull of ten pounds in order to make the gun shoot. As this is too stiff for comfort when shooting a series of rounds at a target, we devise a way of making the recoil of the gun help pull the trigger the next time. Perhaps we rig it up so that as the gun kicks on the first shot, that kick gives a pull of five pounds on the trigger. All we shall have to do is to pull five pounds more to make it go off again, and we have a feedback of 50 per cent. in this case. But perhaps this is still too stiff for easy operation, so we increase the coupling between the trigger of the pistol and the recoil caused by the explosion so that it kicks back on the trigger with a force of nine pounds. Now a one pound pull of our finger on the trigger will be sufficient to fire the next shot. This, then, is a 90 per cent. feedback. If we increase the coupling to the trigger again and let the recoil pull with a pressure of 9.9 pounds, we shall have to exert a force of only one-tenth of a pound to make up the 10 pounds on the trigger, so here we have a feedback of 99 per cent. This, you see, would be a rather desirable adjustment if we wish to make the operation of the pistol easy.

Making it Automatic

Now let us go one step farther. Let the recoil be connected tight enough to the trigger so that it supplies an even 10-pound pressure. In such a case you can see that once you start the pistol operating it will pull its own trigger and continue to fire shots as long as the ammunition lasts. We have then a full-automatic pistol. It is just at this point that the gun begins to operate automatically, the trigger going back and forth continuously once it gets started; and if the coupling between the muzzle and the trigger is made any more power-

ful than this, violent oscillations will be continued indefinitely.

Your vacuum tube is just like a pistol. The grid circuit is the trigger. That is, the input to the tube is always connected to the grid, as it is the point of control. The plate circuit is the muzzle, as it is the output of the tube. Here is where the telephones are always connected, and, as in the case of a revolver, a small amount of energy applied to the grid (trigger) causes a large amount of energy to come out of the plate (muzzle). The way you connect the muzzle to the trigger is through the feedback or tickler. In the most popular form of hook-up the tickler is a coil connected in the plate circuit between the tube and the telephone. This coil is placed close to another coil which is connected to the grid (trigger). So you see that when the energy shoots out of the plate it goes through the plate coil or tickler and affects the grid coil, so feeding back part of its energy to start the action all over again. When you turn the tickler it merely rotates the plate coil so that it is farther away from the grid coil or else points it another direction, so that its action on the grid coil is greatly reduced.

Something for Nothing

Of course, something for nothing can be had only in buying oil stock, so in the present instance we must look for a source of power. When you shoot off a pistol this source is the gunpowder which explodes, and it is part of the energy of this gunpowder which is fed back to help you pull the trigger the next time. In your tube set the source of energy is the "B" battery. Sometimes this is called the phone battery because the current operating the phones comes from it. Assume, then, that it takes 10 millivolts (a millivolt is the unit of electrical pressure) to operate the grid of your detector. If you have the tickler adjusted so the electricity coming from the plate feeds back five millivolts to the grid, then your signal strength must be five millivolts to be heard. If you in-

crease the feedback to give nine millivolts, then you can hear a signal which comes in with the strength of only one millivolt. And if, as before, we feedback 9.9 millivolts, your signal has to have only one-tenth of a millivolt strength to operate your telephone. Perhaps you have never had the pleasure of shaking hands with a millivolt, but you realize that it is a unit of measuring electrical pressure on your grid just as a pound is a unit of measuring mechanical pressure on the trigger of your pistol.

Now the Tube Oscillates

You will see that if we increase our feedback once again so that 10 or more millivolts are fed to the grid from the plate, we will immediately make the tube

oscillate, just as the pistol oscillated when we fed 10 pounds or more back to the trigger. And once it starts oscillating it will continue to do so until it runs out of ammunition ("B" battery voltage). These oscillations are revealed to us by the squeals which are heard in the telephone.

The next question is how to stop it. Getting back to our pistol, the obvious way of stopping its continuous operation is to reduce the connection between the muzzle and the trigger. The most desirable amount of connection is naturally around 99 per cent. or so; enough feedback so that the recoil from the muzzle will do practically all the work, but will leave just enough for our finger so that the gun will not go off except when we

want it to. The same thing applies to the detector. If we increase the feedback to a point where the tube oscillates (squeals) and then turn it down one or two divisions until the squeal just disappears, we shall have a similar condition, namely, the tickler doing most of the work, but leaving just enough for the broadcasting waves to do, so that they, and not the tickler, will operate the set. By this adjustment you will not only stop squealing in your neighbor's radio, but you will also get the most sensitive point of adjustment for your own reception.

In the next issue of RADIO PROGRESS will be discussed the real meaning of the inductance of a coil and the capacity of a condenser.

A Lifetime in a Second

ANY radio expert will tell you how fast radio waves travel; that they go seven times around the earth between two ticks of a clock. The corresponding time taken to travel any moderate distance is, of course, very small indeed, and so the listener-in is familiar with the idea of a very short length of time, but it has remained for Mr. J. F. Peters to go to the limit. Mr. J. F. Peters is an electrical engineer at the Westinghouse Electric Company at East Pittsburgh. He has invented a form of camera called a klydonograph, which is able to take a picture of an electrical discharge which lasts for $2/100,000,000$ of a second. To get an idea of how small a time this is just notice that the relation of this instant to a minute is about the same as the relation of one second to a lifetime of sixty years.

Pictures in the Dark

This instrument itself is shown in the photograph. It consists in general of a specially designed camera holding a sensitive photographic plate. Above this are located a series of surge receivers. These receivers are so spaced that they conduct the electric disturbance to be photographed down into intimate contact with the sensitized plate. The klydonograph is connected to the circuit to be tested through the medium of a condenser or else a transformer coil depending on the type of test desired. One peculiar thing about the operation is that no flash of light is visible at all, although the photographic plate is affected. This means either that the



Fig. 1. Westinghouse Engineer Takes Pictures in the Dark

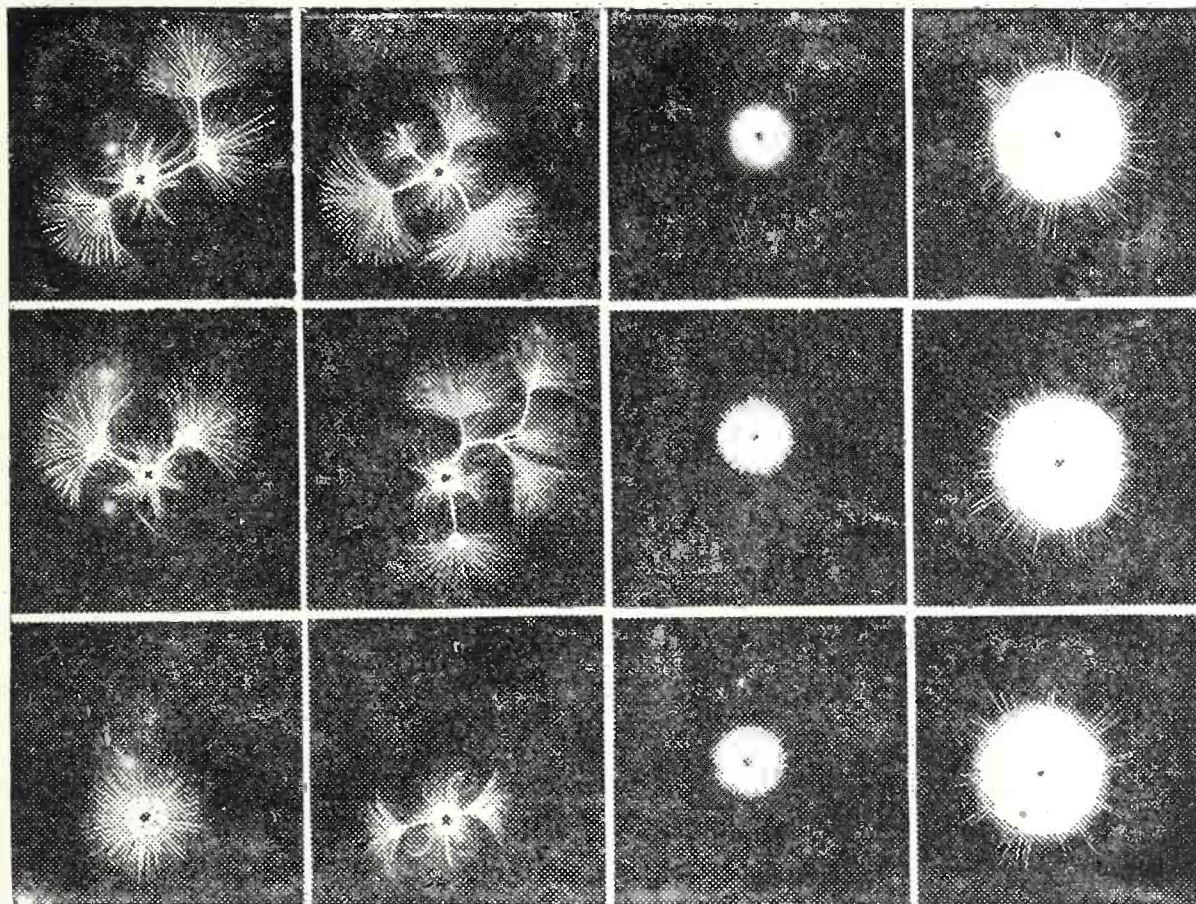

Fig. 2. Pictures Showing How Lightning Arrestors Work

impluses have some peculiar form of wave motion which will affect a plate, or, what seems more likely, the human eye is too slow acting to catch such infinitesimal flash.

Like Snowflakes

The photographs which are obtained by this method resemble snowflakes in the multitude of beautiful shapes. But there is this difference. Whereas snowflakes vary in their shapes, the picture which Mr. Peters obtains shows a decided tendency to fall into definite groups. In the illustration for instance, we see three different sets. One style is that displayed by alternating currents, while the other two show the picture of direct current flashes, positive and negative. The intensity of the photograph is a pretty good indication of the intensity of the voltage causing the flash.

It Helps Protect Your Set

Although this invention was intended principally to be used in testing transmission lines, it is of considerable interest to the radio fan. By means of the data obtained it is possible to improve the existing form of lightning arrestors to a great degree. Arrestors are used on all transmission lines and are very necessary to keep your elec-

tric lights alive during the thunder storms which occur in summer time. Another important use for an arrester is to protect your aerial. The fire insurance underwriters require that every outside aerial be so protected. It is by testing out the effects of strokes of lightning on an instrument like this that the design of arrestors is improved from time to time. As a matter of fact, so efficient is modern lightning protection that it is reported that during the last two years not a single case is on record in the city of New York where any house so protected has been damaged by lightning in any way.

VARNISH YOUR SET, BUT NOT YOUR COILS

We all know that a nice coat of varnish improves the appearance of your radio very much, but do you realize that the same varnish, when painted on your coils is a detriment to the set? To understand why such is the case you must consider what goes on in the coil. As you are doubtless aware, a coil of wire, whether in the form of a honeycomb or spider web winding, is intended to slow down the speed of vibration of the radio waves; that is, the bigger the coil the slower the set will vibrate or oscillate;

but every coil has some condenser action as well. This is undesirable. This condenser action is caused by the various turns of wire, which are separated by layers of insulator. Look at the variable condenser in your set and you will notice that it consists of a lot of pieces of metal separated by an insulator, in this case air. Now the same effect which you get in your variable condenser, namely, that of metal pieces with insulator between them, obtains in the coil, and that is why we get what is called distributed capacity.

Now to get back to our varnish. It is found by experiment that if you have a condenser and have varnish for the insulator between the plates instead of air that the capacity measure of the condenser is several times as great as it was with air. So, you see, when you varnish your coils you are filling the little air spaces up with varnish and so increasing the distributed capacity by several times.

If you want to use something that will hold the wire in place, then a solution of collodion is about as good as anything. Even this is not as good as leaving the coils unimpregnated and just fastening down the ends of the wires with a little sealing wax.

What Will Broadcasting Be in 1925?

Many Present Stations Will be Closed, but the President Will Talk to the Whole Nation

ALL indications point to the gradual elimination of small stations. When you listen in on the air tonight and have difficulty in separating station PDQ from station XYZ you are likely to broadcast a few choice remarks yourself to your listening friends. You very likely consign one of the stations to a place where the wires would melt, and you are probably quite right, as there are altogether too many broadcasting stations in the United States at the present time.

Not Enough Talent

As a matter of fact there is not enough good talent in the country to keep all the stations supplied with programs which are good and interesting, and the result is that a great deal of rather inferior entertainment goes on the air. If all this poor stuff could be eliminated, and only the highest class entertainers be supplied to your favorite broadcasting station, wouldn't you think it was a tremendous improvement. But the question is, How can it be done?

With their customary foresight the Radio Corporation of America has in the past year been attempting to solve this very problem. Their attitude is that if a few high powered stations throughout the country could send out programs to a host of smaller sending stations, then they could easily afford to serve you with the best talent in the country, and you would be able to receive with an ordinary set instead of trying to use a super-radio-hetro-neutro-dynamo-dyne set with $7\frac{1}{8}$ tubes in it.

There are two ways of sending out from what might be called a parent broadcasting station. One is to relay the programs by long distance telephone. Then local stations broadcast this material received over the phone. Such a system is in regular operation at Station WEAJ New York. This studio sends out Roxy programs every Sunday evening to Station WCAP in Washington and WJAR in Providence. On the whole, such a method of relaying is very satisfactory. The reception is surprisingly good as the long distance telephone line

over which the music goes from New York is specially selected for its freedom from noise and its clear transmitting powers. However, there are two objections to the system. In the first place, it is quite expensive to lease a long distance telephone line and hold it out of service so long, and in the second place, such a relaying scheme is rather limited in extent, as it is not practical to have the toll line from the parent station to the local station too long.

Radioing the Radio

The second possible method of relaying is the one which is being developed now by the Radio Corporation. It consists in carrying the program from the parent broadcaster to the various local stations, not by a toll line but by special high frequency radio waves. This might be called radioing the radio. The actual method of operation is like this. Some one station, located at a strategic point, gets from the best talent in the country a performance of unusual interest. This program is not put on the air as ordinary radio waves of 250 meters to 550 meters, such as you receive on your own radio set. The waves used are the extremely high frequency oscillations of three to four hundred million per second with a wave length less than 100 meters long. Such waves make no impression at all on your radio, but do have the very unusual tendency of going through static without being materially affected. Furthermore, they are not disturbed at all by interference from other stations nor from code stuff.

What Can You Do with Three Hundred Million Vibrations?

What can you do to hear this high frequency on your radio? The answer is you can not do anything, but a broadcasting station near you with special receiving equipment can get these vibrations just as plainly as if the performers were singing into their own microphones. This special receiving apparatus in turn transfers the music to an ordinary broadcasting transmitter and so goes out on the air as regular radio

which your set picks up quite easily, in the ordinary way.

This system of primary transmission at high frequency and secondary transmission at ordinary frequency (or wave length) has the very great advantage in that a single pick-up station can send its program all over the United States and into Canada and Mexico, and even to England. Such a system was tried out for the first time in history, on March 7. On that evening the Technology Club, composed of graduates of the Massachusetts Institute of Technology, held its annual dinner at the Waldorf Astoria in New York. Station WJZ, the local broadcaster of the American Telephone and Telegraph, picked up the program and sent it by long distance to WGY at Schenectady. WGY broadcasted it in two ways. The ordinary way was at 380 meters, such as they do regularly with all their programs, and if you were listening at that wave length that night you heard the whole performance, but in addition to that, a second sending apparatus was putting the same program on the air through the ultra short waves. In the meantime KDKA at East Pittsburg had set their ultra short receiving apparatus to pick up Schenectady, and had connected it with their transmitting station at 326 meters, and so they were putting the same program on the air at the same time on their usual wave length.

In addition to the 326 meter wave, another sending instrument was radiating high frequency waves at a speed of over three million a second to stations KFKX at Hastings, Nebraska, and Station 2AC at Manchester, England. The exact wave length for this connecting link was 94 meters, whereas the first jump to East Pittsburg was at 100 meters. This slight change was desirable so that the two sending stations would not interfere with each other. A similar thing happened at the Westinghouse station KFKX at Hastings, Nebraska, and Hastings sent it on in the same manner to the new California station of the General Electric KGO, at Oakland.

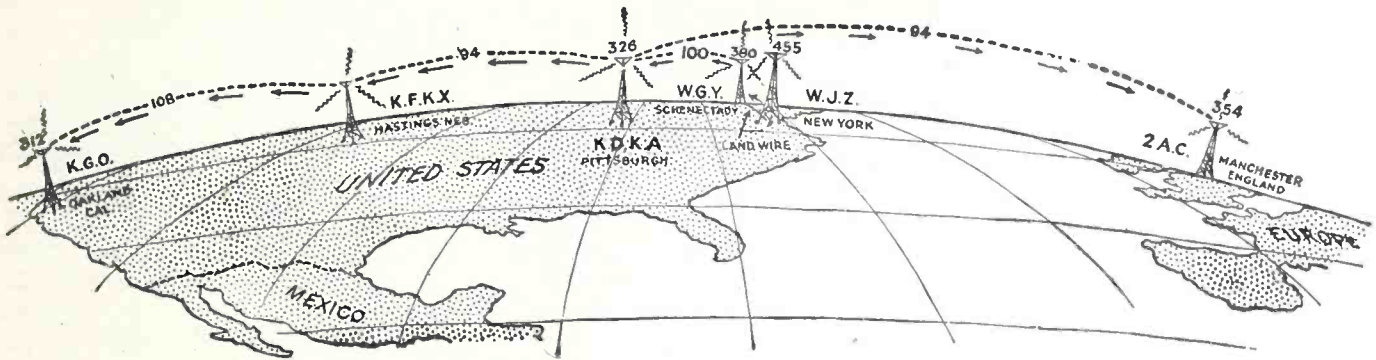

This is the Road Map the Radio Waves Used

All Going at Once

Here then were six stations all going at once, tied together by these new ultra short waves on the primary side, and yet each sending out its characteristic wave length or tone to the listening public who tuned in to their usual meter wave length. For instance, in the Eastern part of the United States, with a reasonably good set, it was possible to get the same speech at the same instant in exactly the same tone of voice from three or possibly four different stations merely by turning the tuning knobs on your set. If static or code happened to interfere with the reception at one frequency, all you had to do was to switch the dials and the speaker kept right on talking from a different State hundreds of miles away.

A Howling Success

Perhaps we should not say "howling" in this connection, as no "howls" were to be heard at all, only a clear, smooth reproduction of the various speakers in their natural tone of voice. But it certainly was a wonderful success. During the evening congratulatory telegrams were read from people all over the United States, and two from England, where the local British Westinghouse Company was relaying the program to the British Isles.

You will notice that the connection between WJZ (New York) and WGY (Schenectady) was made over a wire. The reason for using a wire for this connecting link is that there are so many local broadcasting stations in New York, and also so many amateurs experimenting, that it was feared some slight interference might occur. A further reason was the presence of such an immense number of steel skyscraper structures in the vicinity of WJZ which would have a considerable absorbing effect on the high frequency waves sent

out through the air. For these reasons it was thought advisable to use a toll line to Schenectady and use this powerful General Electric Company sending station as the parent broadcasting station in the series.

Looking Forward to Future Years

It does not seem hard to look forward to the time when most of the small one-horse sending stations in the United States will be suppressed, and a few powerful broadcasting stations will be located at strategic points throughout America, say one every few hundred miles. The stations could all receive relayed programs coming from some one or a few points in the United States. Furthermore, each station could send out several programs at the same time at different frequencies, just as WJZ and WJY are now doing in New York. These two stations, as you no doubt know, are in the same building and are really the same station, but give two simultaneous programs at entirely different wave lengths. The way it would work out would be something like this. There might be, say, half a dozen programs going on at the same time which could be heard anywhere in the United States by a set costing not over ten to fifteen dollars. Such a scheme would involve sending simultaneously, perhaps, the following:

1. Grand opera and classical operatic music.
2. Light opera and musical comedies.
3. Jazz and dance music.
4. Sports and baseball news.
5. Readings, plays and dramatic recitals.
6. Political speeches and addresses of eminent men.

The average radio set would need only some six or eight marks on it, and by turning your dial to any one of these labels, the corresponding program would

come in from the nearest secondary sending station.

Such a system is not necessarily far in the future. The technical development is practically finished on it already as proved by this first successful test by the Radio Corporation of America.

CENSORING BEDTIME STORIES

Big broadcasting stations get some queer mail, and some requests written in that at first sight seem to be rather foolish. Here is a comment from a "listener-in" which is unusual, but seems reasonable when explained.

This letter was written by Mr. F. J. Lee of Lee Valley, Canada, and addressed to the General Electric Station, WGY, Schenectady. Lee Valley is in New Ontario, Canada, and is a very wild country. Big game abounds and bears are quite plentiful. Not the tame kind you see in a zoo, but the wild and woolly variety which thinks nothing of eating a child or even a man when hungry enough.

"I want to file a protest," writes Mr. Lee, "against the bedtime stories for the children about bears eating up little boys or wanting to. Remember, that stuff goes to this new country where there are bears. There are few children going to school who haven't seen a bear. Boys eight or ten years old only laugh at such stuff here, but the little tots are made afraid."

So, you see, the director of a broadcasting station not only has to have a good voice and a pleasing personality, but he also must have a good idea of the parts of the country which his programs reach.

EAR PHONES FREE

See offers on page 32 of this issue explaining how you may secure an Ear Phone or Transformer free.



WHEN any new idea is sprung on an astonished world or a new enterprise is launched, some people will send roses and others will heave rocks. As this second issue of RADIO PROGRESS goes to press we are happy to tell you that we have received a good many roses and also some rocks. As a sample of the former, here is one of a number of letters referring to the crystal set described on page 17 in our last issue. With Mr. Walker's permission, we reproduce it:

RHODE ISLAND TEXTILE ASSOCIATION
Providence

GENTLEMEN: I built a crystal set after the idea suggested in your first number using a spider web coil with eight taps and a switch instead of five taps and a clip. It took me about two hours including the time necessary to wind the coil.

I have built and operated about every kind of a radio receiver including a super hetrodyne but this little hookup has them all skinned. I can put WJAR on the loud speaker as well as WEAN and by the addition of a .0005 variable in the antenna can tune very sharply. I use a Music Master loud speaker, so you see there is no amplification added. I consider that a rather remarkable performance. I live in Providence about a mile in direct line from WJAR.

Very truly yours,

E. F. WALKER,
Secretary, R. I. T. Assn.

Several of the rocks came from people who think that publishing a magazine twice a month is not advisable. Some recommend making it a weekly, while others prefer a monthly. What do you think about it yourself? We would appreciate a postal card from every one of our readers expressing an opinion as to how often such a magazine as this should be published.

In this connection may we suggest that it would be well to order your copy of RADIO PROGRESS from your newsdealer in advance, or, better yet, send in a subscription, as many newsstands ran out of the first issue a couple of days after it appeared.

HAM AND FAN

One of the mysteries of radio which we cannot explain is this: Why is the listener to code called a "ham" and the same chap when listening to music and broadcasting called a "fan?" Whatever the reason may be, there is doubt that the two classes are not on the best of terms with each other. The "hams" are sore because the "fans" have succeeded in pushing through legislation requiring that they keep off the air with their code sending between the hours of eight to ten-thirty every evening, and the "fans" are disgusted because, in spite of this legislation, some hardy spirits persist in sending out dots and dashes during these hours. Furthermore, they do not hold their wave length down to 200 meters and below as required by law. As a result, we hear a rich tenor voice singing "You Wonderful Girl, You Dah de dah dah—dah de dah."

Of course, the code interference is caused very largely by amateurs whose sets are improperly adjusted. In the endeavor to get as much radiation as possible so as to be heard at long distances, they overload their apparatus and so destroy the sharp tuning necessary to keep the radiation at a short enough wave length so as not to interfere with broadcasting. Some of the interference comes from ship stations supposed to be radiating at 600 meters, but

which carelessly have dropped down to the broadcasting band. These latter will be taken care of shortly by the radio department of the government. A movement is on foot for the first time to curb the trouble of such ship code interference.

But how can we get rid of the troublesome "ham?" We disagree with the majority of radio magazines in thinking that we want to get rid of him. So many people take the attitude that in the past the code worker has aided a great deal in the development of the science of radio, and that for this reason we should cater to him in the future, but this is a mistake. Amateurs who have so little engineering ability that they are not able to adjust their sets in accordance with the law, certainly are not smart enough to help much in developing a very technical science which is already advanced to a position far beyond them. So we advise you to find out who it is who is disturbing you with code during the broadcasting period, either by reading his signature or getting some friend who knows the code to tell you. Then write to the radio inspector of your district and ask that the offending operator be required to adjust his set correctly or else keep off the air. It is only by concerted action of the radio listeners that this nuisance can be eliminated.

THE AIR DOES NOT BREAK.

As we approach the spring and summer seasons all the listeners in who have had a year or more experience will sigh regretfully at the thought of all the trouble from static which may be in store for us. They then think regretfully of the telephone and electricity which continue to operate smooth-

ly day after day and wish that static could be eliminated to bring radio into the same class. But when you begin to think such dismal thoughts, just remember what happened during this last severe storm which affected a large part of the whole United States.

When we looked out the window at the results of the first day's storm we said, "What, a blizzard in the middle of March? Impossible." But the next night when all the lights went out and refused to return by coaxing with new fuses we decided that a blizzard

was possible in the middle of March. And when we started to call up the electric light company to report we could not see, we found the telephone wires were all down and we could not hear. On top of this the oil burner in the cellar, which is driven by electric power, stopped working, the temperature in the living room dropped to zero (as measured by the chills up and down our spine) and we realized that we could not feel.

Under these dismal conditions we turned on our radio and to our

immense joy found that, while all the other wires were broken, the air was unbroken. Floods of beautiful melodies rolled in through the loud speaker and solaced our soul.

For the first time the realization struck home that, although radio has the disadvantage that it is affected by outside disturbances like static and interference, it has the balancing advantage that it cannot be put out of business by snowstorms and blizzards severe enough to cripple all other kind of electrical utilities.

Station HVST signing off--Good night

Lines for Lady Listeners

Edited by Miss Opal A. Mowry

Contributions for this department will be accepted if they are of special interest to women

Housewives Now Pick Their Menus from the Air.

If Your Husband Gets Tired of Your Cooking, Here's Your Chance to Get a New Line.

An Interview with Mrs. Wood

Mrs. Wood of Station WJAR, the Outlet Company, Providence, R. I., broadcasts recipes every Monday, Wednesday and Friday morning of each week, beginning at 10 a. m. and lasting for one hour. The talk consists of an introduction, recipe, then a poem or joke to end the talk. She established this exchange of ideas and recipes for women about one year ago. Since then, from receiving two or three letters a day, it has grown to 80 and 90 letters per day. It evidently has been a helpful source of knowledge to women folks, as they all seem to be so enthusiastic about it.

Mrs. Wood also receives letters from gentlemen listeners occasionally, telling her of the new things that they have been given to eat, and at times they seem to be interested in the introductory talk.

On account of daytime broadcasting, the area covered is not so large as in the evening; but she has heard from New York State, all through Maine, New

Hampshire, Connecticut, all parts of Massachusetts and all outlying towns in Rhode Island.

Many letters are received from invalids, shut-ins and a large number of children.

Mrs. Wood usually broadcasts about four to five recipes each time, and all are pronounced a success. Some are from very fine cooks and housewives of 35 years and more experience, who are much interested.

Bedtime Stories for the Kiddies

Every mother would like to have her child quiet and calmed down from the day's excitement as bedtime draws near, thereby making it easy for her to get the child to sleep; for if a child is excited it is much harder for sleep to overtake him than if he is not. The child is called in from play for supper, and then, of course, is kept in for the rest of the evening. He becomes restless and uneasy after a while, and usually starts playing some game or games which in time become more or less exciting for the youngster, making it very hard to quiet him down when Mother thinks it's time for bed. Radio in the home is a great help to mothers, as bedtime stories are broadcast every evening for the kiddies, and any child is willing to sit quietly and listen to the stories. Sometimes not only bedtime stories are broad-

cast, but also some child from the broadcasting station will speak, sing or tell some interesting story. In this way the children are quieted and then are nicely prepared for sleep. This entertainment for the children every evening is on the air early enough for them to listen to all of it and yet retire at their usual hour.

In one well known city where broadcasting is done the names and birthdays of all the children under a certain age are kept account of, and on each one's birthday a "Happy Birthday" is broadcast to him, calling him by name and making some little remark about the child which pleases the kiddies very much.

Each one is always listening in on his birthday (as well as other days), anxiously waiting to hear just what the voice at the other end is going to say about him. It is thrilling for the child to hear his own name called over the radio.

Dumb Luck

Professor—What is ordinarily used as a conductor of electricity?

Student (all at sea)—Why-er—

Professor—Wire. Correct! Now tell me, what is the unit of electric power?

Student (still at sea)—The what, sir?

Professor—Exactly, the watt. Very good. That will do.—Pep.

DIALS ARE DYING

Some of the sets coming through have a rather unusual operation. That is, they have no dials to be turned. This is quite an innovation, and looks like a step in the right direction. Instead of a dial, the knob carries a pointer which travels over a cardboard scale. When you first hear your favorite broadcasting station on this set, you immediately write its call letters on the cardboard opposite the pointer, so the next time you want to tune to that station you swing the pointer to cover this call. This is done with all of the stations you hear. At the end of a few days you will find twenty or more calls recorded, and so when your friends come in and ask to listen to Station PDQ, instead of apologizing for the static, the condition of your battery and the size of your gridleak, you just turn your knob around to PDQ and immediately get a flood of glorious music.

Of course, it is unnecessary to state that such a system cannot be used except on modern sets which require only one or two controls.

WHAT TO EAT BY RADIO

Of all the good things to eat which have been reported to us as coming in over the radio, this one is the best:

Radio Peanut Butter Fluff

Two cups granulated sugar, 2 squares grated chocolate, $\frac{1}{2}$ cup sweet milk. Boil slowly together until mixture makes a soft ball in cold water. Remove from fire and add 2 tablespoons butter, 2 tablespoons peanut butter, 2 tablespoons marshmallow cream, pinch salt; flavor with vanilla. Pour into buttered pan, and cut when nearly cold.

Mrs. M. W. S., of Providence, who contributes this, says if you cannot make a success of this you're no cook.

NEWS BY EAR AND EYE

Many newspapers are coming to the conclusion that they can disseminate news by the ear as well as by the eye. Up to the present time fifty-five different newspapers in the United States have installed broadcasting stations and supplemented their printed pages with oral radiograms. The chief complaint of their patrons seems to be that the radio furnished no comic page. If "Spark Plug," "Polly" or "Mutt and Jeff" could be made to appear through the air, then the newspapers would probably be superseded immediately.

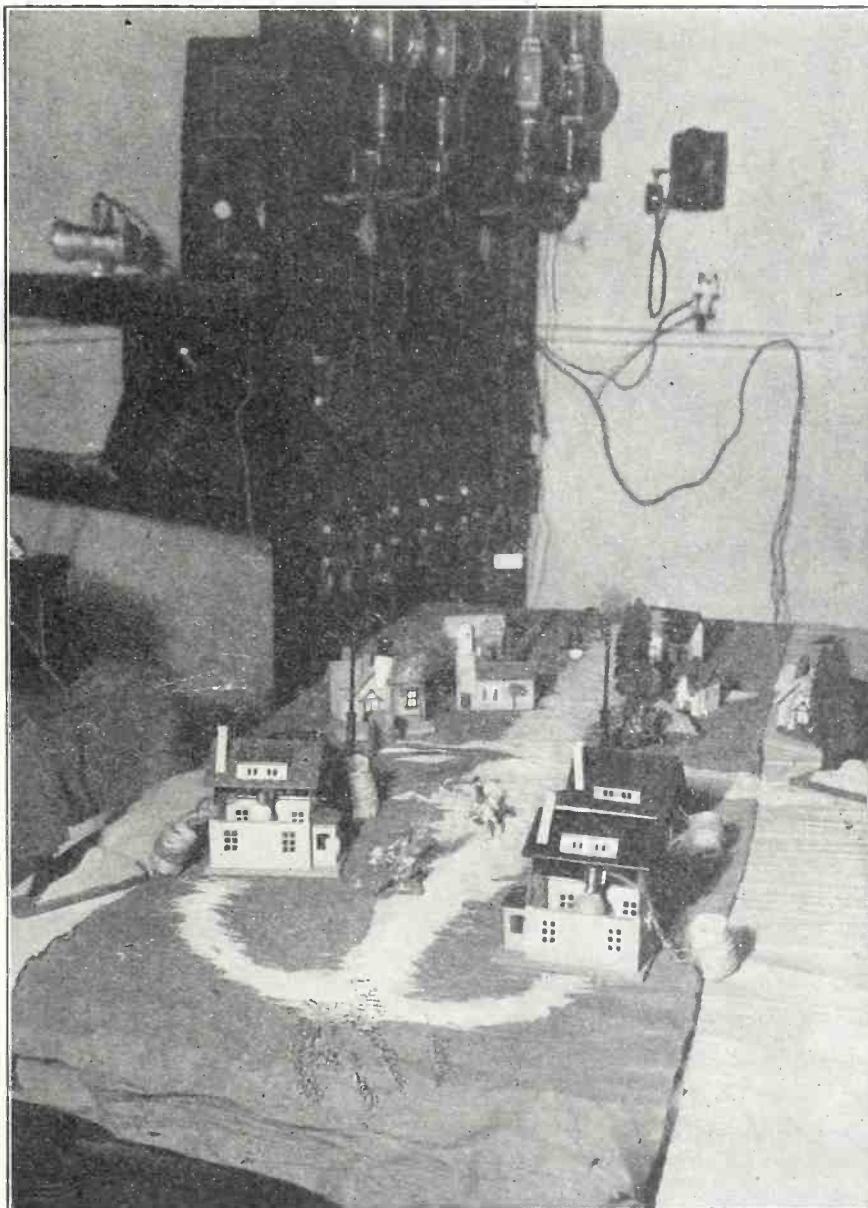

This Village is Lighted by Radio

—Foto Topics

WILL CITIES OF THE FUTURE BE LIGHTED VIA RADIO?

Can you imagine your future home lighted and heated by Radio? This seems almost out of the question but many things which have been thought of as impossible have been done so that we almost believe that everything is possible in this age of inventions. If this system can be actually carried out on a small scale then there is no question about it working on a large scale. How strange it would seem to have your house lighted and heated by energy which you knew came from many miles away.

This is an interesting photograph of the miniature "wireless city" of John High, Jr., constructed in his laboratory at Station 2GR in Riverdale, N. Y. Mr.

High is experimenting with the sending of waves of energy by radio frequency, and has succeeded in sending current a few feet lighting the lamps in the miniature houses, and even running tiny motors. By using a small variometer, he can raise, lower, put on and off the various lights at will, as each unit has a fixed condenser attached acting as a miniature receiving station, attuned to a varying wave length. Mr. High hopes to develop the transmission of radio power, and sees in the future whole communities lighted, heated, and run by radio energy generated by a central station perhaps hundreds of miles distant. Photo shows the radio village of John High, Jr., his 1000-watt transmitter being seen in the background.

Behind the Scenes at Station WGY

Do You Know How a Broadcasting Studio Works? You Will Know if You Read This

An interview with Mr. Kolin Hager

MANY people think that the chief requirement of a broadcasting announcer is to have a sweet and melodious voice. However, that is not nearly enough. Brains of a high order are just as essential, and, although you can not hear them over the radio, you will realize their need when you see some of the things the announcer has to take care of. Perhaps a better title for the article would be "Director of Broadcasting."

One of the most popular stations in the United States is that of the General Electric Company at Schenectady. This station is now in its second year. Mr. Kolin Hager has been in charge of station WGY since it started.

"I made my first announcement on the night of February 21, 1922, with many misgivings," says Mr. Hager.

"I had rehearsed just what I was going to say, 25 or 30 times, and then, when the time for the announcement arrived, I said something altogether different from that which I had intended."

No Scenery to be Seen

The WGY studio is a comfortably furnished suite of rooms on the first floor of a new office building. The room from which come the songs and selections, the speeches and the readings, the comedies and the dramas is furnished with nothing in the way of scenery such as is found in theatres, yet it was only a few days ago that the studio officials received a call from a traveling scenic artist who had been told that he might land a job at WGY painting scenery for the radio.

"One day the phone rang rather vigorously," said Mr. Hager. "I answered it and received this message: 'My husband is dead, thank God, and I wish you would broadcast the fact.'"

Not so long ago the WGY Players, a dramatic organization built up for the broadcasting of plays delivered the comedy "Get Rich Quick Wallingford" in a most excellent manner. The story of the play has to do with the exploiting of an invention for "carpet covered carpet tacks," and it is really amusing,

as all Wallingford stories are. Not long after the play was broadcast the studio received a visit from a woman who appeared very much excited.

"You have exposed my secret," she said. "I have been working for a considerable length of time on this proposition, and just as I get it perfected I hear you broadcasting it to the world, telling every one about it."

"Absolute silence in the studio is most essential," said Mr. Hager, "and it is with the utmost difficulty that we are able to impress this upon the artists or speakers who may be on the program. This silence must be maintained after the song or speech has been finished until the power has been cut off. But very often a vocalist will turn about, immediately after finishing a song, and while standing in front of the microphone say, 'Did I sing that all right?'"

Green and Red Lights

High up on the wall, in plain view of any one who happens to be in the studio, are two lights, one green and the other red. Mr. Hager explained that the green light indicated power on the antenna, while the red light indicated that the microphone was open for broadcasting.

The microphones do not come into view at the first survey of the studio. The first thought of the uninitiated person upon stepping into the studio is that a considerable number of floor lamps are used. Several of them with small ornate silk shades are located in various sections of the room. Closer inspection, however, discloses the fact that instead of electric lights, the fringe of the shade conceals the microphone.

On one side of the room, just under the red and green lights, is a mahogany table on which rests a small leather-covered box with a small lever projecting from it. A small microphone sits alongside of the box-like arrangement. The artist stands in front of the "floor-lamp;" the announcer—when he is announcing—sits at the table with the microphone and switch box in front of him. When everything is arranged and

the speaker, singer or player is ready to start, the announcer takes his place, turns the small lever to the left and makes his announcement. After doing so he takes a final look over the room to be sure that all is arranged and then moves the lever to the extreme right, cutting out his microphone and cutting in the one in front of the artist. The concert is on. Not one sound—other than the sounds which are supposed to occur, must be made. The red light is glowing.

A Lead Covered Booth

Leaving the table, the announcer goes across the studio to a booth in one corner. This booth, built on the style of those used by telephone companies, is covered with felt and sheet lead and is as near sound proof as is mechanically possible. Windows enable him to see everything that is going on in the room. A small radio set enables him to receive from the air just what is being spoken, played or sung in the studio. An ordinary telephone connects with the control room adjoining. His small set enables him to hear just what is going on in the same manner in which it is being heard hundreds of miles away.

Back at his table, as the number draws near to its completion, the announcer is ready to make the switch to his own microphone just as soon as the last word is spoken or sung, or the last note is struck. The red light dies out, the green one comes on and when the program is completed and the power turned off in the control room adjoining, this light also is extinguished.

"The 'Good night' of the announcer does not mean that we have completed our work," said Mr. Hager. "But when we say it we mean it and try to convey to our thousands of friends a friendly thought."

Have You a "Broadcasting Voice?"

All of the entertainment which goes out over the WGY radio station is voluntary. The services of the artists are donated. "Very often," said Mr. Hager, "after the regular program has been completed we must start in trying out

singers or entertainers who have come in during the course of the evening. It is the only time that most of them can come, as many of them are employed or otherwise engaged during the day. We give them a try-out. Often it is found that a person with a wonderful voice is not at all suited for radio broadcasting. This all takes time. We go from one thing to another."

Requests to broadcast personal messages are frequent. "These requests are just as diversified as the classified columns of a newspaper," said the announcer, "and many of the requests cover exactly the same subjects as are contained in the newspaper want, lost and found ads. Not so long ago a man came in with a request that we broadcast the fact that he was an expert watchmaker out of work. He thought that he might be able to get a good job if we would only do that. We have been requested to broadcast all kinds of lost and found articles."

Not All Joy from WGY

Of all the hundreds of news bulletins which have been broadcast from WGY, Mr. Hager pointed to those announcing the deaths of President Harding and former President Woodrow Wilson as the saddest. "We did very important work, I think, during the Japanese disaster," said Mr. Hager, referring to the many messages which had passed through the station during that tragic period.

"News of the finding of Verner Alexanderson, the youngest child of E. F. W. Alexanderson, the man who has done so much to make long distance radio broadcasting possible, was the most joyful message ever sent out of the station, I think," reflected Mr. Hager.

Mr. Hager is assisted in his work of arranging the details of the work of arranging programs and in making the announcements by a staff of assistant announcers. These include Robert Wiedaw, "R. W. announcing;" Carl Jester, tenor soloist, "C. J.;" Asa Coggershall, "A. C.," who gives particular attention to the humorous numbers, and E. H. Smith, "E. H. S.," who directs the "WGY Players."

THE MAN WITH ONE THOUSAND BULL POWER VOICE

If there is one man who needs to bellow about one thousand times as loud as any mortal speaks, it is the director

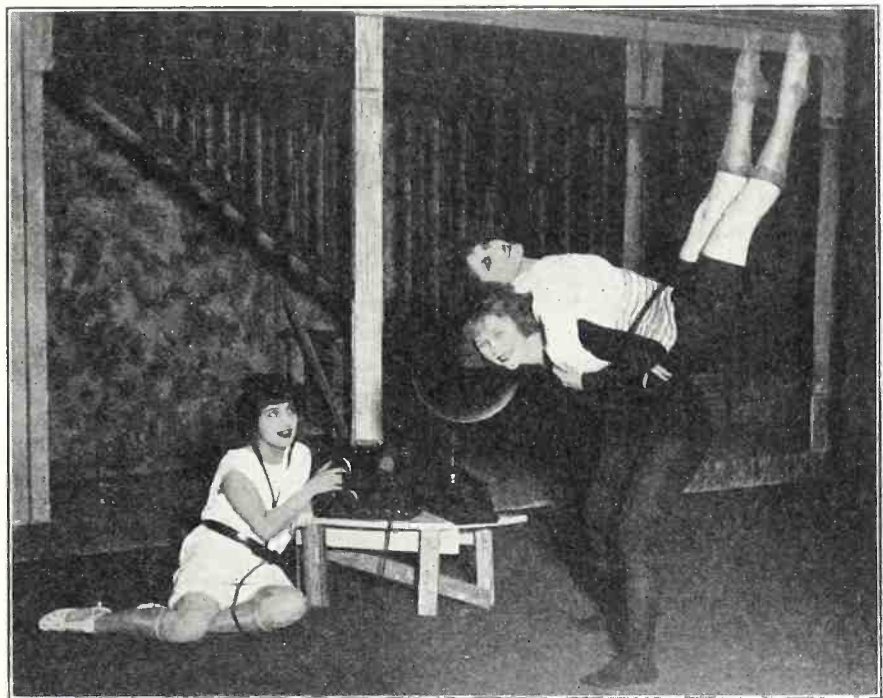

—Underwood & Underwood

Shall Have to See This Show When it Comes to Town

"DAILY DOZEN" BY RADIO

One fellow on seeing this picture asked us when they were going to transmit sight by radio as well as sounds. He said he wanted to be on the air when they broadcast from this studio. This shows the studio of the "Topsy and Eva" Company of Chicago. Three of the chorus are limbering up so they will be able

to do their stuff on the stage for the next performance.

Judging from the form of exercise, we should say that the music coming in must be a lively fox-trot. In fact, a very lively, lively fox-trot. We do not know how good the performance is of the radio shown in the picture, but we want to congratulate the director of the chorus on being a very good picker.

of a moving picture production. You can realize how he has to strain his voice during rehearsals if he is to get all the players, musicians, stage hands and property men to hear him at once. When it comes to making a moving picture, however, and the company is "on location" (as we believe they call it) making any one of these movies that cost two million dollars, according to their press agents, you can see that the director has even more trouble. How is he going to throw his voice so that each of the ten thousand performers who are advertised to take part will know when to look pleasant and when to cry?

Here is where broadcasting steps in. Instead of hollering at the top of his voice, the director merely stands in front of the microphone and talks in an ordinary tone. The transmitting set sends out waves to the various loud speakers installed every one hundred or two hundred feet apart, and not one of the performers (unless dead) can fail to hear

the slightest whisper of the director. The only objection which the directors have to this system is that they must be particularly careful in making side remarks as they used to be able to, as they find some of the actors object to having the director's opinion that they are dumbbells broadcast to the whole company.

Those who have heard "Roxie" speak from New York will be interested to know that the first use the Capitol Theatre made of these microphones was to assist Mr. Rothafel in giving his directions to his performers at rehearsal. The system worked out so well that now his concerts are broadcast from three big cities, New York, Washington and Providence.

RADIO FANS

You can get parts or sets in return for a little work on your part. See the advertisement on page 32 of this issue.

Radio Reported in Best of Health

Radio Corporation Annual Report Shows Reduced Prices and a Bright Outlook

THE great strides made by radio in the past twelve months and its rise to a leading national industry, are reflected in the annual report of the Radio Corporation of America for 1923, made public recently. The report shows a total of \$26,394,789 in gross income for 1923, as against \$14,830,856 for 1922. Its net income for period of 1923 is given as \$4,737,774, as compared with \$2,974,579 for 1922 and \$426,799 for 1921.

The Corporation's financial position has been further strengthened during 1923. Current assets have increased \$3,531,791 and exceed current liabilities by \$8,000,467.

Outstanding Developments of the Year

Two additional radio communication circuits were opened for commercial service during the year, the report declares. These connect the United States with Italy and Poland, making in all nine channels of international message traffic. Nine radio circuits are now in operation to Great Britain, Norway, Germany, France, Italy, Poland, Japan, Hawaii, and Hawaii to Japan. "The service thus rendered to American business interests and the enterprise of the Corporations in developing new international radio connections," the report continues, "means much in developing foreign trade and in preserving friendly relations with other nations." Plans for high-power trans-oceanic stations in Brazil have been approved. Service to the Argentine, on a deferred rate basis, through the medium of the high-power station at Buenos Aires, was inaugurated in February of the present year.

The exchange of traffic with the Republic of China is expected to prove profitable according to the report and will serve to foster trade between that country and the United States. Preliminary surveys for the erection of stations in China has already begun. In this enterprise the Federal Telegraph Company of California invited the participation of the Radio Corporation and the Federal Telegraph Company of Delaware was formed.

Since its inauguration, the Radio Corporation has been the pioneer in mod-

erate rates for Trans-Atlantic messages. From the pressure of our competition undoubtedly resulted the reduction in rates to Great Britain and France, which was announced by the cable companies in April, 1923. Their rates were reduced to agree with those already maintained by us and similar reduction was soon made to other European points. The subsequent operation of our Trans-Atlantic circuits indicates that competition with the cables on even terms is being successfully met. By a rearrangement of the Central Radio Office in New York, it is now possible to handle overseas message traffic by twelve distinct circuits.

"The great value of radio communication over other methods in emergencies," says the report, "has been demonstrated on various occasions." During five days in March, when severe storms interrupted the land lines to the Pacific Coast, we assisted the news associations and successfully handled a large volume of press matter between New York and San Francisco.

"In October, during the World's Series baseball games in New York, wires to San Francisco were again interrupted and, for the first time, a baseball game was described play by play, by radio from New York to San Francisco. During the Japanese disaster in September, uninterrupted radio communication was maintained with the stricken Empire and the worry of an anxious world was allayed by our service."

Marine Radio Communication

The Radio Corporation operates marine coastal stations which communicate with ships at sea. These stations are now located at: Chatham, Mass., New York, N. Y., Cape May, N. J., San Francisco, Cal., Los Angeles, Cal.

"Our service between ships and shore has undergone considerable change during the year," says the report. "Improved types of apparatus have enabled us permanently to close our coastal stations at New London, Conn., and Siasconset, Mass. The service formerly rendered by them is now performed with greater efficiency by the Chatham, Mass., station. The closing of the stations men-

tioned is pursuant to our policy of eliminating interference with radio broadcast programs, caused by marine spark transmitting apparatus, by using only continuous wave tube transmitters in shore to ship service."

"The free medical service made available on ships at sea through measures inaugurated by your officers in co-operation with the U. S. Public Health Service, and the Seamen's Church Institute of New York has rendered urgent emergency aid on many occasions during the year," the report continues. Approximately 75 passenger vessels are now regular subscribers to the nightly press service which the RCA maintains through their coastal stations.

At the beginning of the year the Corporation furnished radio apparatus on a rental and service basis to 705 ships. By the close of the year these had been increased to 759. "A feature of the year's activity," says the report, "was a contract for furnishing the S.S. Leviathan with radio equipment, and its operation by your Corporation."

Sales

The report speaks of the phenomenal growth of broadcasting and of public interest therein and adds:

"During the year 1923 about 450 radio broadcasting stations have been in operation in the United States. The development of non-radiating receiving apparatus of greater selectivity will make this great number of stations a real asset to the radio broadcast listener, pending the time when natural evolution of the art may bring fewer stations more efficiently distributed and of better grade and higher power."

Distribution of Radio Corporation products is accomplished through 116 distributors with 57 branches, making 173 wholesale outlet points. Many thousands of retail dealers serve as a link between these large distributors and the consumer.

"There are still many problems to be solved in the broadcasting situation," the report says, "and your engineers are devoting themselves to their solution with the ambition of perfecting the ser-

Continued on Page 27

The Fight is Still On

Shall Broadcast Music be Taxed, or shall it be as Free as Air?

THE fight is still being continued between the National Association of Broadcasters and the American Society of Composers, Authors, and Publishers. This latter society has been collecting taxes from motion picture theatres, hotels, dancing academies, dance halls, schools of music, etc., for some time for permission to use the music copyrighted by their society, but the National Association of Broadcasters thinks that instead of paying for their service the performers and broadcasters should receive a commission from the music publishers.

The Best Kind of Ad

Their position is, briefly, this: When a new piece of music is brought out, no one at first asks for it, as, of course, it is not generally known. If the composer is willing to spend thousands of dollars, he can make it known fairly well to the general public, but even at that the public may not want to buy. But if the composer can get one of the big broadcasting stations to put the new song on the air, then millions of people will hear it first hand, and if it has any merit, they will be influenced to buy a copy of the sheet music. Why should this form of advertising be given free to composers? Why should the broadcast-

ing station pay the composer for the privilege of advertising his song?

Having Your Cake and Eating It

During the year 1922 the broadcasting stations of the United States were going peacefully along their way, broadcasting whatever good music seemed to be desired by the listening public. From out of a clear sky came a demand by the American Society that they forthwith be paid a substantial sum of money for the privilege of broadcasting a number of selections, the copyrights of which were claimed to be under the society's control. This demand surprised the broadcasters beyond expression, because they always considered that a distinct service was being given these publishers when their musical numbers were broadcast, and if there was any paying to be done, the publisher should pay the broadcaster.

The First Meeting

A meeting of the broadcasters was called at Chicago in April, 1923, on which occasion they organized the National Association of Broadcasters, one of its objects being protection against the demands of the American Society, which were considered unfair.

A second meeting was held in February, 1924. This meeting was attended by representatives of motion picture

theatres, hotels, dancing academies, dance halls, schools of music, outdoor shows and radio broadcasters.

At this meeting the National Association disclosed the effective and practical plan which they had evolved during the past year for providing radio broadcasting stations with "tax free" music.

Broadcasters Have Plan

The meeting was unanimous in its decision to adopt the broadcasters' plan of obtaining relief from the taxation now imposed by the American Society of Composers, Authors, and Publishers, as the interests of all in this meeting were found to be identical. It was, therefore, decided to support the broadcasters' program by sending a letter to each organization representing the above public performers of music, inviting cooperation and pointing out the objects to be attained.

Most of the broadcasting stations are now members of the National Association of Broadcasters. They do not play any pieces unless licensed to do so by the publishers. This is the reason some of your favorite selections which come under the control of the American Society of Composers can not be put on the air. This perhaps explains why you never hear certain pieces for which you have sent in many requests.

Radio in Best of Health

Continued from Page 26

vice to the satisfaction and benefit of the American public."

Gross sales of radio receiving apparatus amounted to \$22,465,090.

General

The report states that the Radio Corporation has recently been made the object of a complaint by the Federal Trade Commission and adds, "The position of the Corporation, with regard to this, has been that it welcomes the opportunity to make a complete review of its history, organization and policies to that body." The Directors of the Radio Corporation are confident that when the investigation is fully completed and finally considered, the position of the Corporation will be found to be entirely sound and proper.



Breaks World's Record

HOW IS THIS FOR SPEED?

This picture shows Mr. A. E. Gerhard, of the Radio Corporation of America, who can receive code faster than the sender can think up words to transmit. He actually was able to get ordinary code messages at the speed of 59½ words every minute, topping the previous record of 56 words a minute by a comfortable margin. This unusual speed was shown at the Fourth Annual Convention of the Second District Executive Radio Council at the Pennsylvania Hotel, New York, March 7.

You can appreciate what this speed means better when you realize that the ordinary message sent from ship to shore comes in at about twenty words per minute. It appears that he well deserves the beautiful trophy awarded by the Radio Council to the winner of the contest.

R DR RADIO PRESCRIBES.

NOTE: In this section the Technical Editor will answer questions of general interest on any radio matters. Any of our readers may ask not more than two questions, and if the subjects are of importance to most radio fans they will be answered free of charge in the magazine. If they are

of special interest to the questioner alone, or if a personal answer is desired, a charge of fifty cents will be made for each answer. This will entitle the questioner to a personal answer by letter. However, if the question requires considerable experimental or development work, higher rates will be charged, which may be obtained upon application.

Question. Why is it that some stations come in better at night and others in the daytime?

Answer. Radio transmission at night is about three times as good as in the daytime. This is probably caused by the fact that when the sun shines the high frequency light waves (the so-called ultra violet rays) cause a form of interference with the waves from the broadcasting station. The precise manner in which these waves react is not known, but it is thought that away up in the atmosphere, twenty to fifty miles above the earth, an action takes place something like what occurs inside your vacuum tubes. At such a height the air is so rarified that it is nearly a perfect vacuum. Whatever the mechanism of operation, no doubt exists as to the fact—the sunlight has a disturbing influence on broadcasting. This explains why you can hear most stations much farther at night than you can in the daytime.

On the other hand, an occasional report will be made of reversed conditions; that is, a station will come in during the daytime and yet not be heard at night. A well known illustration of this is the reception of WGI, Medford Hillside, Massachusetts, as heard in Providence. This station is very difficult to pick up in Providence at any time, owing to a dead spot in the air between the two cities. Powerful sets are able to get the afternoon broadcasting from WGI, but it is very rare that even the best sets can obtain them in the evening.

The reason for this unusual condition is to be found in the wave length of this station. They send out 360 meters, the most popular wave length in the

United States. If you will run your eye down the wave length column of the list of stations as found on Page 31 of this issue, you will notice that this particular wave length is represented by several times as many broadcasters as the next most popular one. During the daytime most of the other stations are silent, and so we get no interference, and the program sent out from Medford Hillside reaches Providence with sufficient loudness to be heard, but at eight o'clock in the evening pandemonium breaks out. Any number of 360 meter stations are going at once, and while they may be so faint that your set does not pick them up in sufficient quantities to be heard distinctly, still they are there strong enough to interfere with the faint reception coming in from WGI. So, of course, you report that you can not get this station.

Question. What is meant by a stabilizer?

Answer. The term stabilizer is used to describe a potentiometer when used on a radio frequency hook-up. The potentiometer looks very much like a rheostat except for two things. In the first place, it always has three terminals, one for the plus of the "A" battery, one for the minus of the "A" battery, and the third connected to the sliding arm for connection to the tuning coil. The second difference in the potentiometer is that it always uses very fine wire and is wound to a resistance of around 400 ohms. If you used a six or thirty ohms potentiometer it would work just as well, but would waste a great deal of electricity from your "A" battery. A six ohm rheostat, for instance, would

consume one ampere out of your storage battery continuously. This, of course, is quite a drain on its capacity. But by winding it with fine wire to a resistance of 400 ohms, the current consumption is cut down to less than 1/50 of an ampere, which is so small that it is almost unappreciable. This small current is plenty big enough to operate the potentiometer.

The chief use of such a stabilizer is in controlling the tubes for the radio frequency amplification. There is a pronounced tendency for these tubes to oscillate with the objection that reception is very mushy and difficult to control. When such a condition occurs in your set it means that you should turn the dial of your stabilizer. This will change the grid potential of your tubes and by the proper adjustment will kill off the oscillation. You will know when this occurs right away, because the mush of the signal will disappear and the music will be much improved.

A stabilizer is usually not used on a set with audio amplification. Sometimes you see a hook-up calling for one, but if you do you will know that it has not been well designed, as a potentiometer in such a set is entirely unnecessary. To be sure, you can vary the signal strength by such a control, but exactly the same variation can be obtained by changing the gridleak, and since this latter must be used, anyway, it is entirely superfluous to have two controls both doing the same thing. On the audio amplification set the oscillating condition of the tubes is controlled by the tickler or feedback.

Question. I have recently added one tube of radio amplification to my set and find it does not work any better than it did when it used a regenerative hook-

up without radio amplification. What is the trouble?

Answer. This is the general experience obtained by changing the regenerative set into a single radio amplification set. When your set is regenerative you get amplification through the feedback of about five to one at an average value. If you take this feedback off and substitute a radio frequency amplification, you will gain the amplification of the radio frequency, but will lose that of regeneration, but it so happens that the multiplication of the radio is just about five to one, so what you have done is to substitute one form of multiplication by five for another form of the same thing, and so, of course, the final result is not very different from what it was at the start.

This is the reason why you will usually find at least two stages of radio frequency amplification on most commercial sets. To be sure, some of the newer hook-ups use radio amplification and regeneration together. In that case a positive gain will be obtained, but the set is much harder to construct and operate.

Question. Is there any possible danger from lightning from an aerial if it is grounded during electrical storms?

Answer. According to the late Charles P. Steinmetz of the General Electric Co., the foremost authority on lightning in the world, an aerial, if grounded during a storm is not a source of danger, but on the other hand is a positive preventive of a lightning stroke reaching the house. This is because the thunder clouds discharge their voltage slowly and harmlessly to the aerial instead of collecting

the charges until they have a sufficient amount of the electricity for a sudden and destructive bolt. It is very much the same idea as a dam. Suppose you have a dam across a river and there is some danger of its breaking in a flood. To prevent such an occurrence you open a sluice-gate in the dam and let the water run out slowly at the same time it runs in, and so it does not accumulate any supply of water behind the dam.

However, realizing that people are forgetful the underwriters specify that in addition to a grounding switch a lightning arrestor must be used, so that if the switch is forgotten and left open during a thunder storm the lightning arrestor will automatically take care of the discharges. As a farther step, if the lightning arrestor is so good that it will operate instead of a grounding switch when the latter is forgotten (and only lightning arrestors approved by the underwriter's laboratories are allowed) then it seems entirely unnecessary to put the grounding switch on at all. That is the reason why the insurance people do not require a ground switch but do demand an approved lightning arrestor.

Question. When my radio squeals how can I tell whether it is a neighbor that is to blame, or that my own set is out of adjustment?

Answer. This is a rather popular question, as it has been asked by various fans. It is a simple matter to tell whether you are squealing in your neighbor's ear or whether he is doing the same to you. The sure test is as follows: Turn the principal tuning dial, the one connected to your variable condenser or your grid variometer (depending on what style of set you use), one degree to

the left or right. Notice particularly the tone of the squeal. If you find that the slight shift in your dial changes the pitch of the squeal note by making it either a slightly higher or a slightly lower note, then the fault is all yours, and you should proceed to adjust your set by reducing the amount of feedback or regeneration. Turn your tickler dial several notches down toward zero and try shifting your tuning dial again. This action should be repeated until the squeal has disappeared from your set.

If, on the other hand, when you turn your tuning dial one degree to the left or to the right, it does not change the pitch of the note, but merely makes it louder or softer with the same tone, then you are out of luck. The squeal is caused entirely by some kind friend in your neighborhood who has adjusted his set wrong by leaving the regeneration dial turned up too high. Unfortunately, there is no remedy for this condition short of getting the offending fan on the 'phone and asking him to cut down his feedback.

Question. Please publish the hookup for the two-tube Harkness set with the diode tube.

Answer. The circuit is shown herewith. Instead of a diode vacuum tube a crystal may be substituted with similar results. The advantages of a crystal are that it takes no battery to operate; is very cheap, and is easily replaced in case of accidental damage. The advantages of the diode are that there is no cat whisker to fuss with, it stays in permanent adjustment, cannot be put out of commission by a heavy static disturbance (as a crystal sometimes is) and is slightly more sensitive than a crystal.

CIRCUIT FOR TWO-TUBE HARKNESS

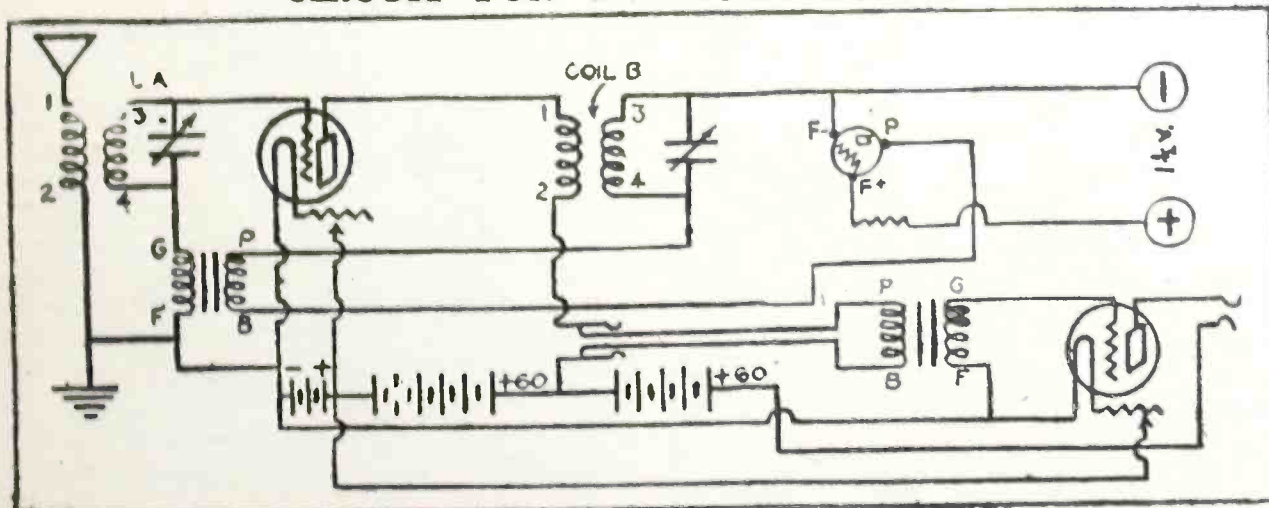

UNITED STATES BROADCASTING STATIONS
ARRANGED ALPHABETICALLY BY
CALL LETTERS

Abbreviations: W.L. wave length in meters; K.C., frequencies in kilocycles; W.P., watt power of station.

		W.L.	K.C.	W.P.
KDKA	Westinghouse Elec. & Mfg. Co., East Pittsburgh.	326-	920-	1000
KDPM	Westinghouse Elec. & Mfg. Co., Cleveland, O.	270-	1110-	250
KDYM	Savoy Theatre, San Diego, Cal.	280-	1070-	100
KDYQ	Oregon Institute of Technology, Portland, Ore.	360-	833-	100
KDYX	Star Bulletin, Honolulu, Hawaii.	360-	833-	100
KDZB	Frank E. Siefert, Bakersfield, Cal.	240-	1250-	100
KDZE	The Rhodes Co., Seattle, Wash.	455-	660-	500
KDZF	Auto. Club of So. Cal., Los Angeles, Cal.	278-	1080-	500
KFAD	McArthur Bros. Mercantile Co., Phoenix, Ariz.	360-	833-	100
KFAE	State College of Washington, Pullman, Wash.	360-	833-	500
KFAJ	University of Colorado, Boulder, Col.	360-	833-	100
KFAO	City of San Jose, San Jose, Cal.	360-	833-	250
KFAR	Studio Lighting Service Co., Hollywood, Cal.	280-	1070-	200
KFAU	In. Sch'l Dist. of Boise City, Boise H. S., Boise, Id.	360-	833-	150
KFBK	Kimball-Upson Co., Sacramento, Cal.	283-	1060-	100
KFCM	Richmond Radio Shop, Richmond, Cal.	360-	833-	100
KFCZ	Omaha Central High School, Omaha, Neb.	258-	1100-	100
KFDH	University of Arizona, Tucson, Ariz.	360-	833-	150
KFDV	Gilbreth & Stinson, Fayetteville, Ark.	360-	833-	200
KFDX	First Baptist Church, Shreveport, La.	360-	833-	100
KFDY	So. Dakota State College, Brookings, So. Dakota.	360-	833-	100
KFEQ	J. L. Scroggin, Oak, Neb.	360-	833-	150
KFEV	Felix Thompson Radio Shop, Casper, Wyo.	263-	1140-	250
KFEZ	Augsburg Seminary, Minneapolis, Minn.	261-	1150-	100
KFFZ	Amer. Society of Mech. Engineers, St. Louis, Mo.	360-	833-	100
KFFO	Markehoffel Motor Co., Colorado Springs, Col.	360-	833-	100
KFFX	McCray Co., Omaha, Neb.	278-	1080-	100
KFFY	Pinous & Murphey, Alexandria, La.	275-	1090-	100
KFGC	Louisiana State University, Baton Rouge, La.	254-	1180-	100
KFGH	Leland Stanford University, Stanford Univ., Cal.	360-	833-	500
KFGJ	Mo. Natl. Guard, 138th Infantry, St. Louis, Mo.	266-	1130-	250
KFGX	First Presbyterian Church, Orange, Tex.	250-	1200-	500
KFHD	Utz Electric Shop Co., St. Joseph, Mo.	226-	1330-	100
KFHF	Central Christian Church, Shreveport, La.	266-	1130-	150
KFHJ	Fallon & Co., Santa Barbara, Cal.	360-	833-	100
KFHX	Robert W. Nelson, Hutchinson, Ks.	229-	1310-	150
KFI	Earle C. Anthony, Inc., Los Angeles, Cal.	469-	640-	500
KFIF	Benson Polytechnic Institute, Portland, Ore.	360-	833-	100
KFIZ	R. C. of Jesus Christ of I. D. Sts., Ind'p'nd'n'e, Mo.	240-	1250-	250
KFIX	Daily C'm'nw'lt'h & O.A. Heuls'm'n, Fond d'L'c, Wis.	273-	1100-	100
KFJC	Seattle Post Intelligencer, Seattle, Wash.	233-	1290-	100
KFJK	Delano Radio and Electric Co., Bristow, Okla.	233-	1290-	100
KFJM	University of N. Dakota, Grand Forks, N. Dak.	280-	1070-	100
KFKB	Brinkley-Jones Hospital Association, Milford, Ks.	286-	1050-	500
KFKQ	Conway Radio Laboratories, Conway, Ark.	224-	1340-	150
KFKX	Westinghouse Elec. & Mfg. Co., Hastings, Neb.	286-	1050-	500
KFLR	University of N. Mexico, Albuquerque, N. M.	254-	1180-	100
KFMQ	University of Arkansas, Fayetteville, Ark.	263-	1140-	100
KFMS	Freimuth Dept. Store, Duluth, Minn.	275-	1090-	100
KFMX	Carleton College, Northfield, Minn.	283-	1060-	500
KGN	Northwestern Radio Mfg. Co., Portland, Ore.	360-	833-	100
KGU	Marion A. Mulreney, Honolulu, Hawaii.	360-	833-	500
KGW	Portland Morning Oregonian, Portland, Ore.	492-	610-	500
KHJ	Times-Mirror Co., Los Angeles, Cal.	395-	760-	500
KHQ	Louis Wasmer, Seattle, Wash.	360-	833-	100
KJR	Northwest Radio Service Co., Seattle, Wash.	270-	1110-	100
KJS	Bible Institute of Los Angeles, Los Angeles, Cal.	360-	833-	750
KLS	Warner Brothers, Oakland, Cal.	360-	833-	250
KLX	Tribune Publishing Co., Oakland, Cal.	360-	833-	250
KLZ	Reynolds Radio Co., Denver, Col.	360-	833-	500
KNT	Grays Harbor Radio Co., Aberdeen, Wash.	263-	1140-	250
KNV	Radio Supply Co., Los Angeles, Cal.	256-	1179-	100
KNX	Electric Lighting Supply Co., Los Angeles, Cal.	360-	833-	100
KOB	N. M. C. of Agri. & Mech. Arts, State Col., N. M.	360-	833-	500
KOP	Detroit Police Dept., Detroit, Mich.	286-	1050-	500
KPO	Hale Bros., San Francisco, Cal.	423-	710-	500
KQV	Doubleday-Hill Electric Co., Pittsburgh, Pa.	360-	833-	250
KSD	Post Dispatch, St. Louis, Mo.	546-	550-	500
KTW	First Presbyterian Church, Seattle, Wash.	360-	833-	750
KUO	Examiner Printing Co., San Francisco, Cal.	360-	833-	150
KUS	Citv Dye Works & Laundry Co., L. Angeles, Cal.	360-	833-	100
KWG	Portable Wireless Tel. Co., Stockton, Cal.	360-	833-	100
KWH	Los Angeles Examiner, Los Angeles, Cal.	360-	833-	500
KYW	Westinghouse Elec. & Mfg. Co., Chicago, Ill.	536-	560-	1000
KZN	The Deseret News, Salt Lake City, Utah.	360-	833-	500
WAAB	Valdemar Jensen, New Orleans, La.	268-	1120-	100
WAAC	Tulane University, New Orleans, La.	360-	833-	400
WAAF	Chicago Daily, Drivers Journal, Chicago, Ill.	286-	1050-	200
WAAM	I. R. Nelson Co., Newark, N. J.	263-	1140-	250
WAAP	Omaha Grain Exchange, Omaha, Neb.	360-	833-	200
WAAS	Hollister-Miller Motor Co., Emporia, Ks.	360-	833-	100
WABA	Lake Forest College, Lake Forest, Ill.	266-	1130-	100
WABE	Young Men's Christian Assn., Washington, D. C.	283-	1060-	100
WABL	Conn. Agri. College, Storrs, Conn.	283-	1060-	100
WABM	F. E. Doherty Auto. & R'dio E. Co., Saginaw, M.	254-	1180-	100
WABN	Off Radio, Inc., La Crosse, Wis.	244-	1320-	250
WABP	Robert F. Weinig, Dover, Ohio.	266-	1130-	100
WABT	Holliday-Hall, Washington, Pa.	252-	1190-	100
WABU	Victor Talking Machine Co., Camden, N. J.	226-	1330-	100
WABX	Henry B. Joy, Mount Clemens, Mich.	270-	1110-	150
WBA	Purdue University, West Lafayette, Ind.	360-	833-	250
WRAD	Sterling Electric Co., Minneapolis, Minn.	360-	833-	100
WBAH	The Dayton Co., Minneapolis, Minn.	417-	720-	500

		W.L.	K.C.	W.P.
WBAN	Wireless Phone Corp., Paterson, N. J.	244-	1230-	100
WBAP	Wortham-Carter Pub. Co., Fort Worth, Tex.	476-	630-	750
WBAV	Erner & Hopkins Co., Columbus, Ohio.	390-	770-	500
WBAW	Marietta College, Marietta, Ohio.	246-	1220-	250
WBAY	American Tel. & Tel. Co., New York, N. Y.	492-	610-	500
WBL	T. & H. Radio Co., Anthony, Ks.	261-	1150-	100
WBR	Penn State Police, Butler, Pa.	286-	1050-	250
WBT	Southern Radio Corp., Charlotte, N. C.	360-	833-	500
WBU	City of Chicago, Chicago, Ill.	286-	1050-	500
WBZ	Westinghouse Elec. & Mfg. Co., Springfield, Mass.	337-	890-	1000
WCAD	St. Lawrence University, Canton, N. Y.	280-	1070-	250
WCAE	Kaufmann & Baer Co., Pittsburgh, Pa.	462-	650-	500
WCAJ	Nebraska Wesleyan Univ., Univ. Place, Neb.	360-	833-	500
WCAL	St. Olaf College, Northfield, Minn.	360-	833-	500
WCAM	Villanova College, Villanova, Pa.	360-	833-	150
WCAP	Chesapeake & Potomac Tel. Co., Wash'g't'n, D. C.	469-	640-	500
WCAR	Alamo Radio Elec. Co., San Antonio, Tex.	360-	833-	150
WCAS	W. H. Dunwoody Ind. Inst., Minneapolis, Minn.	246-	1050-	100
WCAT	S. Dakota State Sch. of Mines, Rapid City, S. D.	240-	1250-	100
WCAU	Durham & Co., Philadelphia, Pa.	286-	1050-	100
WCAV	Kesselman-O'Driscoll Co., Milwaukee, Wis.	261-	1150-	250
WCBD	Wilbur G. Voliva, Zion, Ill.	345-	870-	500
WCK	Stix, Baer & Fuller Dry Goods Co., St. Louis, Mo.	360-	833-	100
WCM	University of Texas, Austin, Tex.	360-	833-	500
WCX	Detroit Free Press, Detroit, Mich.	517-	580-	500
WDAE	Tampa Daily Times, Tampa, Fla.	360-	833-	250
WDAF	Kansas City Star, Kansas City, Mo.	411-	730-	500
WDAG	J. Laurance Martin, Amarillo, Tex.	263-	1140-	100
WDAK	The Courant, Hartford, Conn.	261-	1150-	100
WDAP	Board of Trade, Chicago, Ill.	360-	833-	500
WDAR	Lit Brothers, Philadelphia, Pa.	395-	760-	500
WDAU	Slum & Kilburn, New Bedford, Mass.	360-	833-	100
WDAX	First National Bank, Centerville, Iowa.	360-	833-	100
WEAF	American Tel. & Tel. Co., New York, N. Y.	492-	610-	500
WEAI	Cornell University, Ithaca, N. Y.	286-	1050-	500
WEAJ	University of S. Dakota, Vermillion, S. Dak.	283-	1060-	200
WEAM	Borough of N. Plainfield, N. Plainfield, N. J.	252-	1190-	100
WEAN	Shepard Co., Providence, R. I.	273-	1100-	100
WEAO	Ohio State University, Columbus, Ohio.	360-	833-	500
WEAP	Mobile Radio Co., Mobile, Ala.	360-	833-	100
WEAS	Hecht Co., Washington, D. C.	360-	833-	100
WEAU	Davidson Bros. Co., Sioux City, Iowa.	360-	833-	100
WEAY	Iris Theatre, Houston, Tex.	360-	833-	250
WEB	Benwood Co., St. Louis, Mo.	360-	833-	500
WEW	St. Louis University, St. Louis, Mo.	261-	1150-	100
WFAA	Dallas News & Dallas Journal, Dallas, Tex.	476-	630-	500
WFAB	Carl F. Woese, Syracuse, N. Y.	234-	1280-	100
WFAH	Electric Supply Co., Port Arthur, Tex.	236-	1270-	150
WFAN	Hutchinson Elec. Service Co., Hutchinson, Minn.	363-	830-	300
WFAV	Univ. of Nebraska, Dept. of E. Eng., Lincoln, Neb.	275-	1090-	500
WFI	Strawbridge & Clothier, Philadelphia, Pa.	395-	760-	500
WGAQ	Glenwood Radio Corp., Shreveport, La.	360-	833-	150
WGAW	Ernest C. Albright, Altoona, Pa.	261-	1150-	100
WGAY	Northwestern Radio Co., Madison, Wis.	360-	833-	100
WGI	Am. R'd'o & Res'ch Corp., Med'rd Hills'ide, Mass.	360-	833-	150
WGL	Thomas F. J. Rowlett, Philadelphia, Pa.	360-	833-	500
WGR	Federal Tel. & Tel. Co., Buffalo, N. Y.	319-	940-	500
WGV	Interstate Electric Co., New Orleans, La.	360-	833-	100
WGY	General Electric Co., Schenectady, N. Y.	380-	790-	1000
WHA	University of Wisconsin, Madison, Wis.	360-	833-	500
WHAA	State University of Iowa, Iowa City, Iowa.	283-	1060-	100
WHAB	Clark W. Thompson, Galveston, Tex.	360-	833-	200
WHAD	Marquette University, Milwaukee, Wis.	280-	1070-	100
WHAG	University of Cincinnati, Cincinnati, Ohio.	222-	1350-	100
WHAH	Rafer Supply Co., Joplin, Mo.	283-	1060-	250
WHAM	University of Rochester, Rochester, N. Y.	283-	1060-	100
WHAS	Courier-Journal & Louisville Times, Louisville, Ky.	400-	750-	500
WHAZ	Rensselaer Polytechnic Institute, Troy, N. Y.	380-	790-	500
WHB	Sweeney School Co., Kansas City, Mo.	411-	720-	500
WHK	Radiovox Co., Cleveland, Ohio.	283-	1060-	100
WHN	George Schubel, New York, N. Y.	360-	833-	100
WIAC	Galveston Tribune, Galveston, Tex.	360-	833-	100
WIAJ	Fox River Valley Radio Supply Co., Neenah, Wis.	224-	1340-	100
WIAK	Journal-Stockman Co., Omaha, Neb.	273-	1080-	200
WIAO	School of Eng. of Milwaukee, Milwaukee, Wis.	360-	833-	100
WIAR	Paducah Evening Sun, Paducah, Ky.	360-	833-	100
WIAS	Home Electric Co., Burlington, Iowa.	360-	833-	100
WIK	K. & L. Electric Co., McKeesport, Pa.	234-	1280-	500
WIP	Gimbel Brothers, Philadelphia, Pa.	509-	590-	500
WJAB	American Electric Co., Lincoln, Neb.	360-	833-	500
WJAD	Jackson's Radio Eng. Laboratories, Waco, Tex.	360-	833-	150
WJAG	Norfolk Daily News, Norfolk, Neb.	283-	1060-	250
WJAN	Peoria Star, Peoria, Ill.	280-	1070-	100
WJAO	Capper Publications, Topeka, Ks.	360-	833-	100
WJAR	The Outlet Co., Providence, R. I.	360-	833-	500
WJAS	Pittsburgh Radio Supply House, Pittsburgh, Pa.	360-	833-	500
WJAX	Union Trust Co., Cleveland, Ohio.	390-	770-	500
WJAZ	Chicago Radio Laboratory, Chicago, Ill.	448-	670-	1000
WJX	Deforest Radio Tel. & Tel. Co., N. Y., N. Y.	360-	833-	500
WJY	R. C. A., New York, N. Y.	405-	740-	500
WJZ	Broadcast Central, New York, N. Y.	455-	660-	500
WKAA	H. F. Paar, Cedar Rapids, Iowa.	268-	1160-	100
WKAF	W. S. Radio Supply Co., Wichita Falls, Tex.	360-	833-	100
WKAP	Dutee W. Flint, Cranston, R. I.	360-	833-	250
WKAO	Radio Corp. of Porto Rico, San Juan, P. R.	360-	833-	100
WKAR	Michigan Agri. College, E. Lansing, Mich.	280-	1070-	250
WKY	WKY Radio Shop, Oklahoma, Okla.	360-	833-	100
WLAG	Cutting & Wash. Radio Corp., Minneapolis, Min.	417-	720-	500
WLAH	Samuel Woodworth, Syracuse, N. Y.	234-	1280-	100
WLAJ	Waco Electrical Supply Co., Waco, Tex.	360-	833-	150

RADIO FREQUENCY AMPLIFICATION with the BALLANTINE VARIOTRANSFORMER



How to get increased distance with your crystal set

YOUR crystal set is the starting point on which to build a good distance receiver. For authorities agree that there is nothing finer than a good crystal for clean-cut detection—not so loud as a tube, perhaps, but much clearer. By all means, keep this element with which you are already familiar.

Use tubes to best advantage

Tubes, of course, are needed for amplification—to build up weak distant signals so that they may operate your crystal detector. But, by putting your money for tube equipment into one or more stages of radio frequency amplification, tuned with BALLANTINE VARIOTRANSFORMER Units, you will get increased distance.

Try this instrument. Then, if there's anything you don't understand, our staff will help you out.

Booklet tells how to improve crystal sets

"Radio Frequency Amplification with the BALLANTINE VARIOTRANSFORMER," is the title of our 25-page booklet, packed with useful data, charts and diagrams. Send for your copy now.

BOONTON RUBBER MFG. CO.

Pioneers in Bakelite Moulding

824 Fanny Road, Boonton, N. J.

Complete radio frequency amplifier unit with \$15.00 socket and rheostat
Transformer only \$9.60 for panel or base
At dealers or postpaid

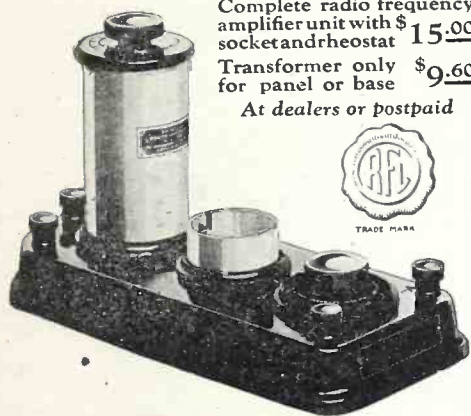

RADIO FREQUENCY AMPLIFICATION with the BALLANTINE VARIOTRANSFORMER

		W.L.	K.C.	W.P.
WLAK	Vermont Farm Machine Corp., Bellows Falls, Vt.	360-833-100		
WLAL	Naylor Electrical Co., Tulsa, Okla.	360-833-100		
WLAN	Putnam Hardware Co., Houlton, Me.	283-1060-250		
WLAW	Police Dept. City of N. Y., New York, N. Y.	360-833-500		
WLW	Crosley Mfg. Co., Cincinnati, O.	309-970-500		
WMAB	Radio Supply Co., Oklahoma, Okla.	360-833-100		
WMAC	Clive B. Meredith, Cazenovia, N. Y.	261-1150-200		
WMAF	Round Hills Radio Corp., Dartmouth, Mass.	360-833-100-500		
WMAH	General Supply Co., Lincoln, Neb.	250-1180-100		
WMAJ	Drovers Telegram Co., Kansas City, Mo.	275-1090-250		
WMAK	Norton Laboratories, Lockport, N. Y.	360-833-500		
WMAQ	Utility Battery Service, Easton, Pa.	246-1220-150		
WMAQ	Chicago Daily News, Chicago, Ill.	448-670-500		
WMAQ	Paramount Radio Corp., Duluth, Minn.	266-1130-250		
WMAV	Alabama Polytechnic Institute, Auburn, Ala.	250-1200-500		
WMAV	Kingshighway Presbyterian Church, St. Louis, Mo.	280-1070-100		
WMC	"Commercial Appeal," Memphis, Tenn.	500-600-500		
WNCAC	Shepard Stores, Boston, Mass.	278-1080-100		
WNAD	University of Oklahoma, Norman, Okla.	360-833-100		
WNAN	Syracuse Radio Telephone Co., Syracuse, N. Y.	286-1050-100		
WNAP	Wittenberg College, Springfield, Ohio	360-833-100		
WNAS	Tex. Radio Corp. & Austin Statesman, Austin, Tex.	360-833-100		
WNAT	Lenning Brothers Co., Philadelphia, Pa.	360-833-100		
WNAV	People's Tel. & Tel. Co., Knoxville, Tenn.	236-1270-500		
WNAX	Dakota Radio Apparatus Co., Yankton, S. D.	244-1230-100		
WOAG	Apollo Theatre, Belvidere, Ill.	224-1340-100		
WOAH	Palmetto Radio Corp. Charleston, S. C.	360-833-100		
WOAI	Southern Equipment Co., San Antonio, Tex.	385-780-500		
WOAL	William E. Woods, Webster Groves, Mo.	229-1310-500		
WOAN	Vaughn Conserv'try of Music, Lawrenceburg, Tenn.	360-833-150		
WOAV	Penn. Nat'l Guard, 2d Bat, 112th Inf., Erie, Pa.	242-1240-100		
WOAW	Woodmen of the World, Omaha, Neb.	526-570-500		
WOAX	Franklyn J. Wolff, Trenton, N. J.	240-1250-500		
WOC	Palmer Sch. of Chiropractic, Davenport, Iowa	484-620-500		
WOI	Iowa State College, Ames, Iowa	360-833-100		
WOK	Pine Bluff Co., Pine Bluff, Ark.	360-833-500		
WOO	John Wanamaker, Philadelphia, Pa.	509-590-500		
WOO	Western Radio Co., Kansas City, Mo.	360-833-500		
WOR	L. Bamberger & Co., Newark, N. J.	405-740-500		
WOS	Mo. State Marketing Bureau, Jefferson City, Mo.	441-680-500		
WPAB	Pennsylvania State College, State College, Pa.	283-1060-500		
WPAC	Donaldson Radio Co., Okmulgee, Okla.	360-833-200		
WPAH	Wisconsin Dept. of Markets, Waupaca, Wis.	360-833-250		
WPAK	North Dakota Agri. Col., Agri. College, N. D.	360-833-250		
WPAL	Avery & Loeb Elec. Co., Columbus, Ohio	286-1050-100		
WPAZ	John R. Koch (Dr.), Charleston, W. Va.	273-1100-100		
WQAA	Horace A. Beale, Jr., Parkersburg, Pa.	360-833-500		
WQAC	E. B. Gish, Amarillo, Tex.	360-833-100		

WQAM	Electrical Equipment Co., Miami, Fla.	360-833-100
WQAN	Scranton Times, Scranton, Pa.	280-1070-100
WQAO	Calvary Baptist Church, New York, N. Y.	360-833-100
WQAO	Abilene Daily Reporter, Abilene, Tex.	360-833-100
WQAS	Prince-Walter Co., Lowell, Mass.	266-1130-100
WQAX	Radio Equipment Co., Peoria, Ill.	360-833-100
WRAA	Rice Institute, Houston, Tex.	360-833-200
WRAL	No. States Power Co., St. Croix Falls, Wis.	248-1210-100
WRAM	Lombard College, Galesburg, Ill.	244-1230-250
WRAV	Antioch College, Yellow Springs, Ohio	360-833-100
WRAX	Flexon's Garage, Gloucester City, N. J.	268-1120-100
WRAY	Radio Sales Corp., Scranton, Pa.	280-1070-100
WRC	Radio Corp. of America, Washington, D. C.	460-640-500
WRK	Doren Bros. Electric Co., Hamilton, Ohio	360-833-200
WRL	Union College, Schenectady, N. Y.	360-833-500
WRM	University of Illinois, Urbana, Ill.	360-833-500
WRW	Tarrytown Radio Research Lab., Tarrytown, N. Y.	273-1100-150
WSAB	S. E. Mo. State Teachers' Col., Cape Girardeau, Mo.	360-833-100
WSAC	Lombard Agri. Col., Clemson College, S. C.	360-833-500
WSAD	J. A. Foster Co., Providence, R. I.	261-1150-150
WSAH	A. G. Leonard, Jr., Chicago, Ill.	248-1210-500
WSAI	U. S. Playing Card Co., Cincinnati, Ohio	309-970-500
WSAJ	Grove City College, Grove City, Pa.	360-833-250
WSAW	Curtis & McElwee, Canandaigua, N. Y.	275-1190-100
WSAY	Irving Austin, Port Chester, N. Y.	233-1290-100
WSB	Atlanta Journal, Atlanta, Ga.	429-700-500
WSL	J. & M. Electric Co., Utica, N. Y.	273-1100-100
WSY	Alabama Power Co., Birmingham, Ala.	360-833-500
WTAM	The Willard Storage B'ttry Co., Cleveland, O.	390-770-1000
WTAN	Orndorff Radio Shop, Mattoon, Ill.	240-1250-100
WTAQ	S. H. Van Gorden & Son, Osseo, Wis.	226-1330-100
WTAR	Reliance Electric Co., Norfolk, Va.	280-1070-100
WTAS	Charles E. Erbstein, Elgin, Ill., near	286-1050-500
WTAT	Edison Electric Illum. Co., Boston, Mass.	244-1229-100
WTG	Kansas State Agri. Col., Manhattan, Ks.	360-833-1000
WWAD	Wright & Wright, Inc., Philadelphia, Pa.	360-833-100
WWAE	Alamo Dance Hall, Joliet, Ill.	227-1320-500
WWAF	Galvin Radio Supply Co., Camden, N. J.	236-1270-100
WWAO	Michigan College of Mines, Houghton, Mich.	244-1230-250
WWI	Detroit News, Detroit, Mich.	517-580-500
WWL	Loyola University, New Orleans, La.	280-1070-100

DEPENDABLE ADVERTISING

Advertising in RADIO PROGRESS is accepted from only those firms who are known to be reliable. You can buy with confidence anything advertised in any issue of this magazine.

RADIO-FANS!

Here's an opportunity to get

PARTS—SETS

Anything you want in the Radio Line

without cost to you

if you will do a little work for us

If you think we have the right idea in RADIO PROGRESS,—if you like the magazine (and remember, this is only the second issue), you will want to receive it regularly. And if you think well enough of our effort to subscribe yourself, you surely will be willing to ask your next-door neighbor to subscribe with you. Therefore, here's

Offer No. 1

If you will send in your own subscription for one year to RADIO PROGRESS (the subscription price is \$3.00 a year) and the subscription of one friend, we will send you by return mail your choice of a fine Radio frequency or Audio frequency

Transformer

or a pair of High-Grade, Guaranteed

Ear Phones

Speak to one of your radio friends to-day! Show him this copy of RADIO PROGRESS. You won't have any trouble in getting him to

subscribe. Then write his name and address, and your own name and address PLAINLY on a sheet of paper and mail, with money-order for \$6.00 to cover the two subscriptions to SUBSCRIPTION DEPARTMENT, RADIO PROGRESS, 8 Temple Street (Post Office Box 728, Providence, R. I.). We'll ship the Transformer or Ear Phones prepaid by return mail. (Be sure to show clearly which address is yours, so we will know where to send the Transformer or Ear Phones, and be sure to tell which article you want.)

Offer No. 2

Get one more yearly subscription, making three in all (including your own), and we'll send you BOTH THE TRANSFORMER AND THE EAR PHONES!!

WRITE TO-DAY!

Address: SUBSCRIPTION DEPT.,
RADIO PROGRESS,
8 Temple Street, P. O. Box 728,
Providence, R. I.

Announcing the "WIZARD ARISTOCRAT"

(All that the name infers)

THE "B" BATTERY SUPREME

Fashioned by experts—from the best materials the market affords—and built in Pawtucket, R. I., assuring fresh stock, longer life and greater efficiency, undisturbed by long hauls and deterioration en route.

Sphinx-like in performance—100% efficient. A "ROLLS-ROYCE" in design, refinement and ENDURANCE—at a **SENSIBLE PRICE.**

COMPARE, DISCUSS and then **DECIDE** to use "WIZARD ARISTOCRAT." "Lends TONE to any Radio Assembly."

DEMAND "THE ROYAL PURPLE PACKAGE" and be secure in the knowledge you have the **BEST.**

SOLD BY RELIABLE DEALERS

TO DEALERS—You can't afford not to sell the "WIZARD ARISTOCRAT." WRITE TO-DAY for full information and dealer proposition.

WIZARD BATTERY CORPORATION

Factory—Laboratories—Executive Offices

381 North Main St.

P. O. Box 238

Pawtucket, R. I.

Coto

"Built First to Last"

Now is the Time to Build your New Portable Set for Radio Outings

When the spring sun gets warm and your old automobile just naturally turns out into the country road and the far hillsides beckon to you, you will want to take your radio with you. So get ready. A Coto compact radio set made according to your favorite hook-up will give you wonderful results wherever you may happen to string your aerial. You can box set, batteries and all neatly in small space if the parts you use are Coto built.

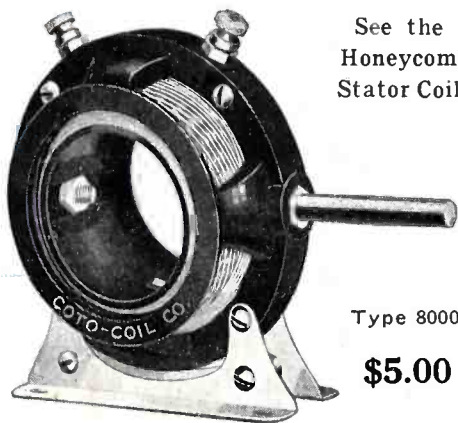

See the Honeycomb Stator Coils

Type 8000

\$5.00

Coto Apparatus is all Guaranteed

"Built First to Last" and always built to uphold our reputation for radio apparatus of a quality second to none. Every Coto part is Laboratory Tested before shipment. Your dealer is authorized to make immediate replacement for any defects that may develop in shipment, or ordinary use. So it is wise to buy Coto.

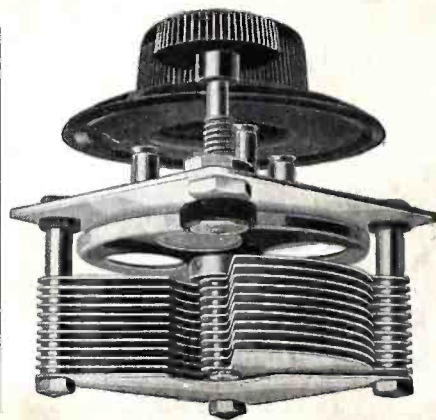

Coto Compact Variometer wins wide Popularity

Its small size, $2\frac{7}{8} \times 1\frac{5}{8} \times 3\frac{3}{4}$, makes it best of all adapted for portable sets. But wide use in sets of standard size has proved it to be equal to the best. Range is 200 to 600 meters. Connections to rotor by pigtail, assuring positive contact. Very handsome in appearance in polished brown bakelite.

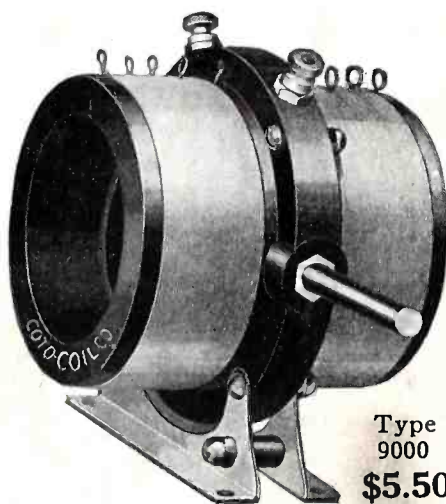

Type 9000

\$5.50

Manufacturers of Fine Radio Sets Turn to Coto

The Coto compact Variable Air Condenser with vernier which is only $2\frac{7}{8}$ inches square is now specified for two high grade radio sets, the makers of which demand the very highest efficiency in an air condenser. Plates are soldered in place and SILVER PLATED. .00025 Mfd., \$4.50. .0005 Mfd., \$5. .001 Mfd., \$6.



It is Tapped Type 5000A \$7.50

For Loop Aerial Reception with Portable Set

The Coto tapped Radio Frequency Amplifying Transformer will operate with marked efficiency. Write for folder of 8 Radio Frequency diagrams in one. Range 180 to 750 meters.

Coto Compact Variocoupler

A companion piece of the variometer and possessing all its features of excellence. With eight taps for use with primary condenser.

Turn Ratio is 5 to 1



COTO-COIL CO.

87 Willard Ave., Providence, R. I.

BRANCH OFFICES:

Los Angeles, 329 Union League Bldg.
Minneapolis, Geo. F. Darling, 705 Plymouth Bldg.
Atlanta, C. P. Atkinson, Atlanta Trust Co. Bldg.

CANADIAN DISTRIBUTOR:
Perkins Electric Co., Ltd.
Montreal, Toronto, Winnipeg

Rich, Full Toned Audio Amplification

Coto compact Audio Amplifying Transformer may be depended upon to give unusual quality of amplification. The ratio is low enough to avoid distortion and high enough to give ample volume. Type 4000. \$5.